

Infusion Disposables Product Catalog



March 2012

Customer Service 1-800-258-5361
www.smiths-medical.com



Infusion Disposables

p5 Gravity Administration Sets
p6 60 Drop
p7 20 Drop
p9 10 Drop
p9 Secondary Sets
p11 Mangum Delivery Sets
p15 Extension Sets
p16 Large Bore
p17 Standard Bore
p23 Small Bore
p30 Small Bore Light Resistant Tubing
p30 Small Bore T-Connectors
p32 Micro Bore
p33 Micro Bore Light Resistant Tubing
p35 Ultra™ Small Bore Extension Sets
p39 Filter Sets
p40 Ultra™ Small Bore Filter Sets
p3938 Filter Sets
p43 Stopcocks
p44 Small Bore
p45 Large Bore Hi-Flo™
p49 Components
p50 Check Valves
p50 Connectors
p51 Caps
p52 1-Way Valve Medifolds
p52 Injection Sites
p53 Needle-Free Access Systems
Index



All Smiths Medical products listed in this catalog are latex-free



Gravity Administration Sets

60 Drop	p6
20 Drop	p7
10 Drop	p9
Secondary Sets	p9

60 Drop

PRODUCT CODE/UPC	DESCRIPTION	FEATURES	APPROX. PRIMING VOLUME	APPROX. OVERALL LENGTH	UNITS PER CASE
SM872M 50351688500456	60 Drop Vented / Non-Vented Spike Gravity Administration Set with 15 Micron Filter, Roller Clamp, 2 SmartSite® Needle-Free Valves, Swivel Luer Lock	<ul style="list-style-type: none"> • Non-DEHP Formulation • Latex-Free 	17 mL	103" (262 cm)	25

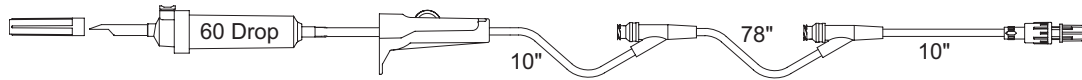

20 Drop

PRODUCT CODE/UPC	DESCRIPTION	FEATURES	APPROX. PRIMING VOLUME	APPROX. OVERALL LENGTH	UNITS PER CASE
MX7322SC 50351688505468	20 Drop Non-Vented Spike Gravity Administration Set with 2 "Y" Injection Site, Check Valve, Roller Clamp, Detachable 2-Gang Hi-Flo™ 4-Way Stopcocks, Male Luer Lock and a 39" Extension, Pinch Clamp, Swivel Male Luer	<ul style="list-style-type: none"> • Non-DEHP Formulation Fluid Path • Latex-Free 	15 mL	101" (257 cm)	25

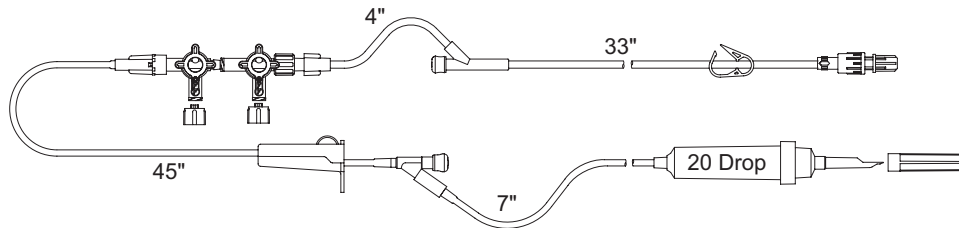

MX821L 50351688504928	20 Drop Non-Vented Spike Gravity Administration Set with 15 Micron Filter, Roller Clamp, Male Luer Lock	<ul style="list-style-type: none"> • Non-DEHP Formulation • Latex-Free 	12 mL	77" (196 cm)	25
---------------------------------	---	--	-------	-----------------	----

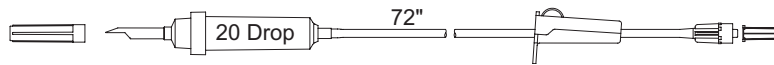

MX821S 50351688504911	20 Drop Non-Vented Spike Gravity Administration Set with 15 Micron Filter, Roller Clamp, Male Luer Lock	<ul style="list-style-type: none"> • Non-DEHP Formulation • Latex-Free 	10 mL	65" (165 cm)	25
---------------------------------	---	--	-------	-----------------	----

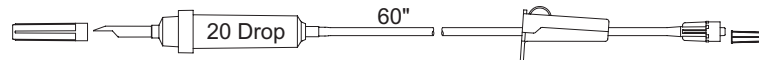

MX822KMA 50351688504898	20 Drop Non-Vented Spike Bifurcated Gravity Administration Set with Back Check Valve, Roller Clamp, 1 SmartSite® Needle-Free Valve, Y-Connector, Detachable Extension with Additional Attachable SmartSite® Needle-Free Valve, Male Luer Lock	<ul style="list-style-type: none"> • DEHP Formulation • Latex-Free 	18 mL	86" (218 cm)	25
-----------------------------------	---	--	-------	-----------------	----

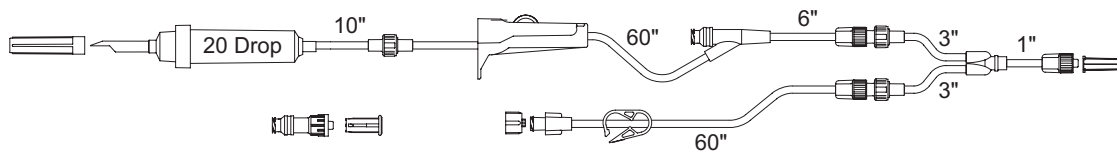

20 Drop

PRODUCT CODE/UPC	DESCRIPTION	FEATURES	APPROX. PRIMING VOLUME	APPROX. OVERALL LENGTH	UNITS PER CASE
MX822S 50351688504874	20 Drop Bifurcated Non-Vented Spike Colored Coded Administration Set with 15 Micron Filter, Slide Clamp, Roller Clamps, Male Luer Locks	<ul style="list-style-type: none"> • Non-DEHP Formulation • Latex-Free 	12 mL	65" (165 cm)	25
MX823S 50351688504867	20 Drop Trifurcated Non-Vented Spike Colored Coded Administration Set with 15 Micron Filter, Slide Clamp, Roller Clamps, Male Luer Locks	<ul style="list-style-type: none"> • Non-DEHP Formulation • Latex-Free 	15 mL	66" (168 cm)	25
MX824 50351688504850	20 Drop Vented Spike Gravity Administration Set with 15 Micron Filter, Roller Clamp, Male Luer Lock	<ul style="list-style-type: none"> • Non-DEHP Formulation • Latex-Free 	18 mL	77" (196 cm)	25
SM5009 50351688500593	20 Drop Vented / Non-Vented Spike Gravity Administration Set with 15 Micron Filter, 1 SmartSite® Needle-Free Valve, Swivel Male Luer Lock	<ul style="list-style-type: none"> • Non-DEHP Formulation • Latex-Free 	17 mL	100" (254 cm)	25
SM872 50351688500470	20 Drop Vented / Non-Vented Spike Gravity Administration Set, 2 SmartSite® Needle-Free Valves, Slide Swivel Luer Lock	<ul style="list-style-type: none"> • Non-DEHP Formulation • Latex-Free 	19 mL	103" (262 cm)	25
SM873 50351688500449	20 Drop Vented / Non-Vented Spike Gravity Administration Set with 15 Micron Filter, Back Check Valve, Roller Clamp, 3 SmartSite® Needle-Free Valves, Slide Swivel Luer Lock	<ul style="list-style-type: none"> • Non-DEHP Formulation • Latex-Free 	19 mL	106" (269 cm)	25

10 Drop

PRODUCT CODE/UPC	DESCRIPTION	FEATURES	APPROX. PRIMING VOLUME	APPROX. OVERALL LENGTH	UNITS PER CASE
SM90976 50351688500418	10 Drop Vented / Non-Vented Spike Gravity Administration Set with Back Check Valve, 2 SmartSite® Needle-Free Valves, Roller Clamp, Hi-Flo™ 4-Way Stopcock, 2-Gang Medifold with 1-Way Valves, Detachable Extension Set with Slide Clamp, Slide Swivel Luer Lock	<ul style="list-style-type: none"> • Non-DEHP Formulation • Latex-Free 	24 mL	144" (366 cm)	25

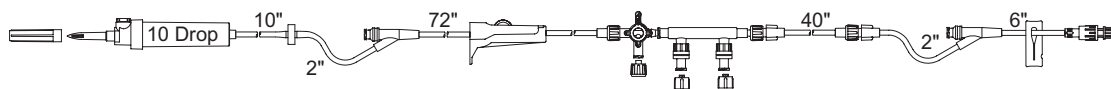

Secondary Sets

PRODUCT CODE/UPC	DESCRIPTION	FEATURES	APPROX. PRIMING VOLUME	APPROX. OVERALL LENGTH	UNITS PER CASE
MX870 50351688504638	20 Drop Vented / Non-Vented Secondary Administration Set with Roller Clamp, Swivel Luer Lock Includes Hanger	<ul style="list-style-type: none"> • Non-DEHP Formulation • Latex-Free 	10 mL	35" (89 cm)	25

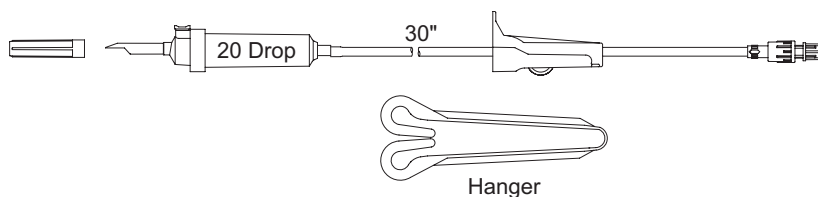

Hanger

Mangum Delivery Sets



Mangum Delivery Sets	p12
----------------------	-----

Mangum Delivery Sets

PRODUCT CODE/UPC	DESCRIPTION	FEATURES	APPROX. PRIMING VOLUME	APPROX. OVERALL LENGTH	UNITS PER CASE
MX448FMG 50351688507479	Vented / Non-Vented Spike Mangum Micro Delivery Administration Set, Pinch Clamp, Back Check Valve, Anti Free-Flow Stopcock, 6" Detachable Extension, 60" Small Bore Extension with 0.2 Micron Filter, Male Luer Lock	<ul style="list-style-type: none"> • Non-DEHP Formulation • Latex-Free • Low Protein Binding Filter 	3.0 mL	74" (188 cm)	25

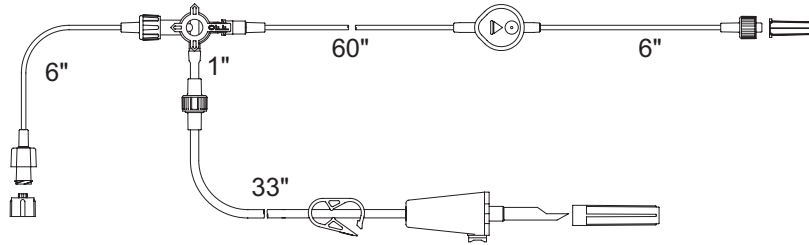

MX448HLMG 50351688507417	Vented / Non-Vented Spike Mangum Micro Delivery Administration Set, Pinch Clamp, Back Check Valve, Anti Free-Flow Stopcock, 6" Detachable Extension, 60" Small Bore Extension, Male Luer Lock	<ul style="list-style-type: none"> • Non-DEHP Formulation • Latex-Free • Non-PVC 	2.5 mL	69" (175 cm)	25
------------------------------------	---	---	--------	--------------	----

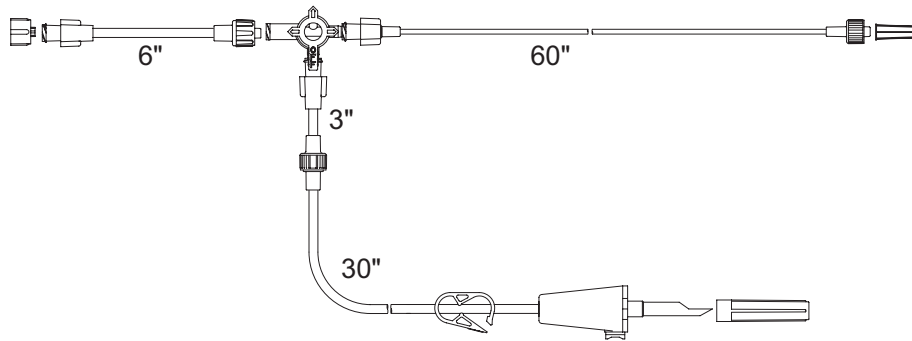

MX448L60MG 50351688507370	Vented / Non-Vented Spike Mangum Micro Delivery Administration Set, Pinch Clamp, Back Check Valve, Anti Free-Flow Stopcock, 6" Detachable Extension, 60" Small Bore Extension, Male Luer Lock	<ul style="list-style-type: none"> • Non-DEHP Formulation • Latex-Free 	2.6 mL	67" (170 cm)	25
-------------------------------------	---	--	--------	--------------	----

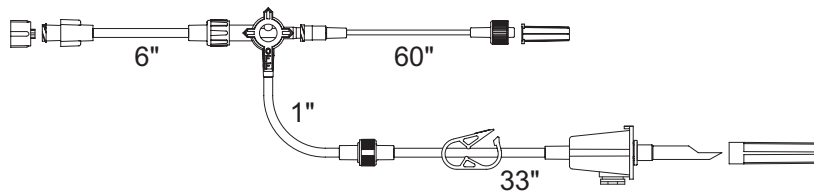

Mangum Delivery Sets

PRODUCT CODE/UPC	DESCRIPTION	FEATURES	APPROX. PRIMING VOLUME	APPROX. OVERALL LENGTH	UNITS PER CASE
MX5096020MG 50351688506830	Vented / Non-Vented Spike Mangum Micro Delivery Administration Set, Pinch Clamp, Back Check Valve, Small Body Anti Free-Flow Stopcock, 60" Small Bore Extension, Male Luer Lock, For use with 1cc Syringes	<ul style="list-style-type: none"> • Non-DEHP Formulation • Latex-Free 	0.5 mL	62" (157 cm)	25

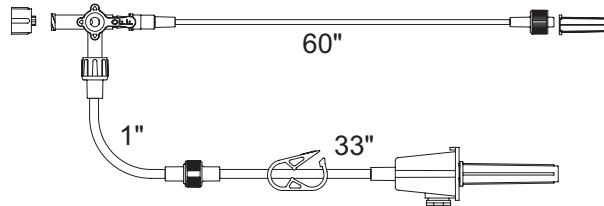

MX536020MG 50351688506755	Vented / Non-Vented Spike Mangum Micro Delivery Administration Set, Pinch Clamp, Back Check Valve, Small Body Anti Free-Flow Stopcock, 6" Detachable Extension, 60" Micro Bore Extension, Male Luer Lock	<ul style="list-style-type: none"> • Non-DEHP Formulation • Latex-Free 	1.3 mL	68" (173 cm)	25
-------------------------------------	--	--	--------	--------------	----

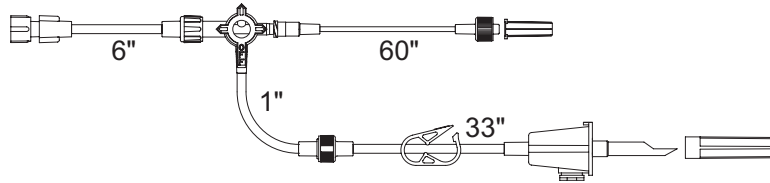

MX536020MGIL 50351688506748	Vented / Non-Vented Spike Mangum Micro Delivery Administration Set, Pinch Clamp, Back Check Valve, Anti Free-Flow Stopcock, 60" Micro Bore Extension, Male Luer Lock	<ul style="list-style-type: none"> • Non-DEHP Formulation • Latex-Free 	0.5 mL	60" (152 cm)	25
---------------------------------------	--	--	--------	--------------	----

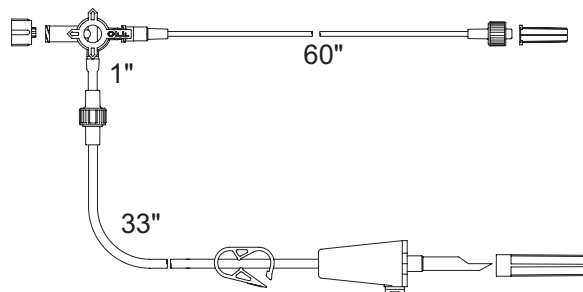



Extension Sets

Large Bore	p16
Standard Bore	p17
Small Bore	p23
Small Bore Light Resistant Tubing	p30
Small Bore T-Connectors	p30
Micro Bore	p32
Micro Bore Light Resistant Tubing	p33

Large Bore

PRODUCT CODE/UPC	DESCRIPTION	FEATURES	APPROX. PRIMING VOLUME	APPROX. OVERALL LENGTH	UNITS PER CASE
MX92133L 50351688504225	4-Way Hi-Flo™ Stopcock, Large Bore Extension, Non-Vented Blue Cap on Middle Port, Male Luer Lock	<ul style="list-style-type: none"> • Non-DEHP Formulation • Latex-Free 	7.0 mL	35" (89 cm)	50

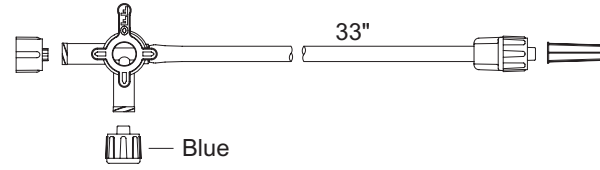

Standard Bore					
PRODUCT CODE/UPC	DESCRIPTION	FEATURES	APPROX. PRIMING VOLUME	APPROX. OVERALL LENGTH	UNITS PER CASE
MX048 50351688510301	Standard Bore Extension with Male Luer Lock	<ul style="list-style-type: none"> • Non-DEHP Formulation • Latex-Free 	5 mL	49" (124 cm)	50
MX20307R1 50351688517799	4-way Large Bore Hi-Flo™ Stopcock, Standard Bore Extension, SmartSite® Needle-free Valve, Slide Swivel Luer Lock	<ul style="list-style-type: none"> • Non-DEHP Formulation • Latex-Free 	3.8 mL	23" (58 cm)	25
MX252L 50351688508230	3-Way Anesthesia Style Stopcock Standard Bore Extension with Injection Site, Non-Vented White Caps, Male Luer Lock	<ul style="list-style-type: none"> • Non-DEHP Formulation Fluid Path • Latex-Free 	2.4 mL	22" (56 cm)	50
MX253L 50351688508223	3-Way Anesthesia Style Stopcock Standard Bore Extension with Injection Site, Non-Vented White Caps, Male Luer Lock	<ul style="list-style-type: none"> • Non-DEHP Formulation Fluid Path • Latex-Free 	3.9 mL	35" (89 cm)	50
MX254 50351688508216	3-Way Anesthesia Style Stopcock Standard Bore Extension with Injection Site, Non-Vented White Caps, Male Luer Lock	<ul style="list-style-type: none"> • Non-DEHP Formulation Fluid Path • Latex-Free 	4.6 mL	42" (107 cm)	50
MX412SL 50351688507868	3-Way Hi-Flo™ Stopcock Standard Bore Extension, Slide Swivel Luer Lock	<ul style="list-style-type: none"> • Non-DEHP Formulation • Latex-Free 	2.6 mL	22" (56 cm)	50
MX413SL 50351688507820	3-Way Hi-Flo™ Stopcock Standard Bore Extension, Slide Swivel Luer Lock	<ul style="list-style-type: none"> • Non-DEHP Formulation • Latex-Free 	4.1 mL	35" (89 cm)	50

Standard Bore

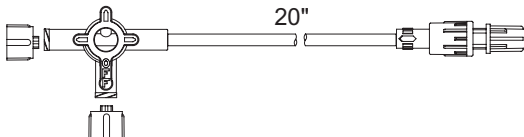
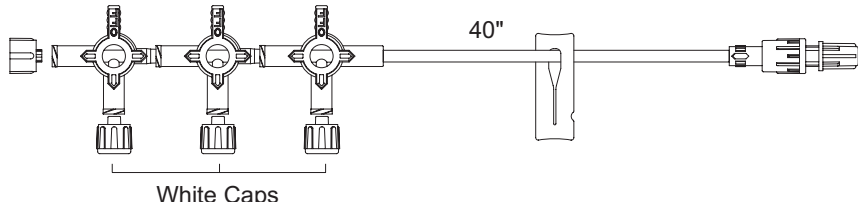
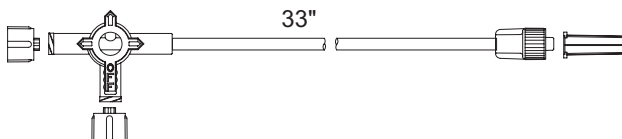
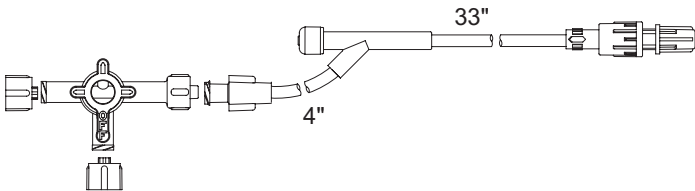
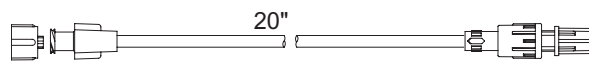
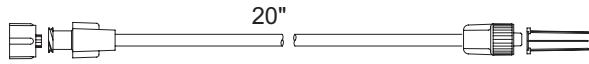
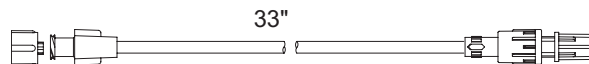
PRODUCT CODE/UPC	DESCRIPTION	FEATURES	APPROX. PRIMING VOLUME	APPROX. OVERALL LENGTH	UNITS PER CASE
MX422SL 50351688507813	Large Bore 4-Way Hi-Flo™ Stopcock Standard Bore Extension, Slide Swivel Luer Lock	<ul style="list-style-type: none"> • Non-DEHP Formulation • Latex-Free 	2.5 mL	22" (56 cm)	50
					
MX4233NS 50351688507806	3-Gang Large Bore 4-Way Hi-Flo™ Stopcocks Standard Bore Extension, Non-Vented White Caps, Non-Removable Blue Slide Clamp, Slide Swivel Luer Lock	<ul style="list-style-type: none"> • Non-DEHP Formulation • Latex-Free 	5.3 mL	44" (112 cm)	25
					
MX423L 50351688507790	Large Bore 4-Way Hi-Flo™ Stopcock Standard Bore Extension, Male Luer Lock	<ul style="list-style-type: none"> • Non-DEHP Formulation • Latex-Free 	3.8 mL	34" (86 cm)	50
					
MX423YSL 50351688507783	Detachable Large Bore 4-Way Hi-Flo™ Stopcock Standard Bore Extension with "Y" Injection Site, Slide Swivel Luer Lock	<ul style="list-style-type: none"> • Non-DEHP Formulation • Fluid Path • Latex-Free 	5.0 mL	40" (102 cm)	50
					
MX450SL 50351688507325	Standard Bore Extension with Slide Swivel Luer Lock	<ul style="list-style-type: none"> • Non-DEHP Formulation • Latex-Free 	2.4 mL	21" (53 cm)	50
					
MX450FL 50351688507332	Standard Bore Extension, Male Luer Lock	<ul style="list-style-type: none"> • Non-DEHP Formulation • Latex-Free 	2.4 mL	21" (53 cm)	50
					
MX451SL 50351688507301	Standard Bore Extension with Slide Swivel Luer Lock	<ul style="list-style-type: none"> • Non-DEHP Formulation • Latex-Free 	4.2 mL	34" (86 cm)	50
					

Standard Bore

PRODUCT CODE/UPC	DESCRIPTION	FEATURES	APPROX. PRIMING VOLUME	APPROX. OVERALL LENGTH	UNITS PER CASE
MX451FL 50351688507318	Standard Bore Extension with Male Luer Lock	<ul style="list-style-type: none"> • Non-DEHP Formulation • Latex-Free 	3.9 mL	34" (86 cm)	50
MX452 50351688507288	Standard Bore Extension with Pinch Clamp, Male Luer Lock	<ul style="list-style-type: none"> • Non-DEHP Formulation • Latex-Free 	0.8 mL	7" (18 cm)	50
MX452FL 50351688507271	Standard Bore Extension with Male Luer Lock	<ul style="list-style-type: none"> • Non-DEHP Formulation • Latex-Free 	0.8 mL	7" (18 cm)	50
MX454FL 50351688507165	Standard Bore Extension with Removable Slide Clamp, Male Luer Lock	<ul style="list-style-type: none"> • Non-DEHP Formulation • Latex-Free 	2.3 mL	21" (53 cm)	50
MX455FL 50351688507158	Standard Bore Extension with Removable Slide Clamp, Male Luer Lock	<ul style="list-style-type: none"> • Non-DEHP Formulation • Latex-Free 	4.0 mL	34" (86 cm)	50
MX456CVL 50351688507134	Standard Bore Bifurcated Extension with 2 Back Check Valves, Male Luer Lock	<ul style="list-style-type: none"> • Non-DEHP Formulation • Latex-Free 	1.0 mL	5" (13 cm)	50
MX456R 50351688507110	Standard Bore Bifurcated Extension, Non-Vented Blue Caps with Rotating Male Luer Lock	<ul style="list-style-type: none"> • Non-DEHP Formulation • Latex-Free 	0.6 mL	3" (8 cm)	50

Standard Bore

PRODUCT CODE/UPC	DESCRIPTION	FEATURES	APPROX. PRIMING VOLUME	APPROX. OVERALL LENGTH	UNITS PER CASE
MX456L 50351688507127	Standard Bore Bifurcated Extension, Non-Vented Blue Caps, Male Luer Lock	<ul style="list-style-type: none"> • Non-DEHP Formulation • Latex-Free 	0.6 mL	3" (8 cm)	50

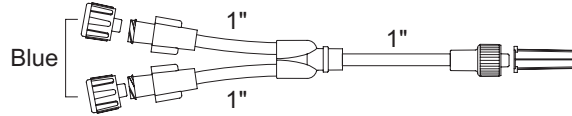

MX458L 50351688507073	Standard Bore Color-Coded Trifurcated Extension with Pinch Clamps, Non-Vented Blue Caps, Male Luer Lock	<ul style="list-style-type: none"> • DEHP Formulation • Latex-Free 	1.8 mL	6" (15.2 cm)	25
---------------------------------	---	--	--------	--------------	----

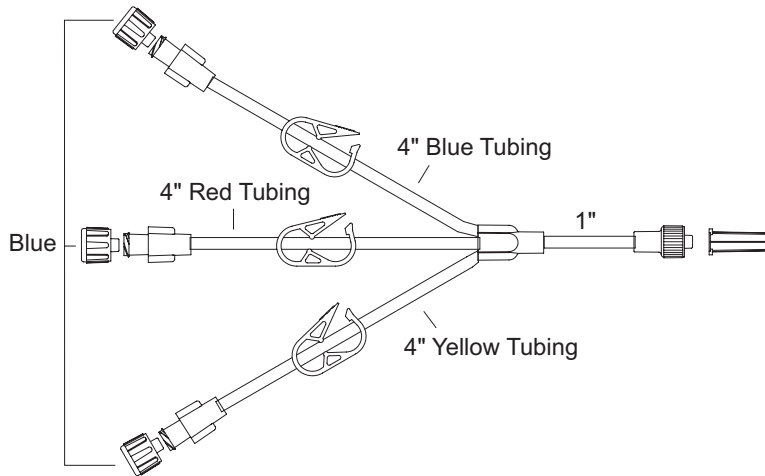

MX522L 50351688506823	Small Bore 4-Way Stopcock Standard Bore Extension with Male Luer Lock	<ul style="list-style-type: none"> • Non-DEHP Formulation • Latex-Free 	2.5 mL	22" (56 cm)	50
---------------------------------	---	--	--------	-------------	----

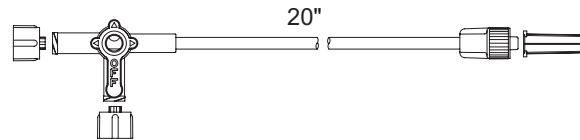

MX522SL 50351688506816	Small Bore 4-Way Stopcock Standard Bore Extension, Non-Vented Blue Cap on Middle Port, Slide Swivel Male Luer Lock	<ul style="list-style-type: none"> • Non-DEHP Formulation • Latex-Free 	2.5 mL	22" (56 cm)	50
----------------------------------	--	--	--------	-------------	----

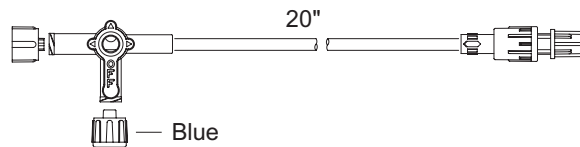

MX7222SC 50351688505543	2-Gang Large Bore 4-Way Hi-Flo™ Stopcocks, Detachable Standard Bore Extension with "Y" Injection Site, Pinch Clamp, Slide Swivel Male Luer Lock	<ul style="list-style-type: none"> • Non-DEHP Formulation • Latex-Free 	5.2 mL	40" (102 cm)	25
-----------------------------------	---	--	--------	--------------	----

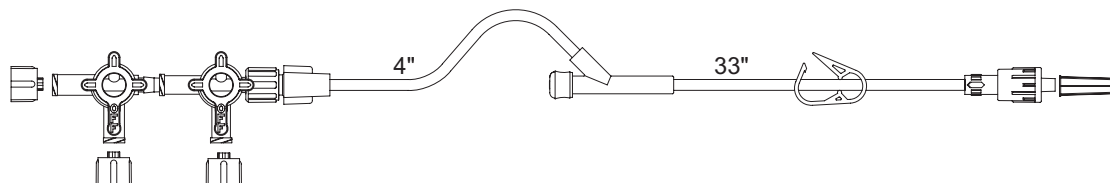

Standard Bore

PRODUCT CODE/UPC	DESCRIPTION	FEATURES	APPROX. PRIMING VOLUME	APPROX. OVERALL LENGTH	UNITS PER CASE
MX7223SC 50351688505536	3-Gang Large Bore 4-Way Hi-Flo™ Manifold, Non-Vented Blue Caps on Middle Ports, Detachable Standard Bore Extension with “Y” Injection Site, Pinch Clamp, Slide Swivel Male Luer Lock	<ul style="list-style-type: none"> • Non-DEHP Formulation Fluid Path • Latex-Free 	5.5 mL	42" (107 cm)	25

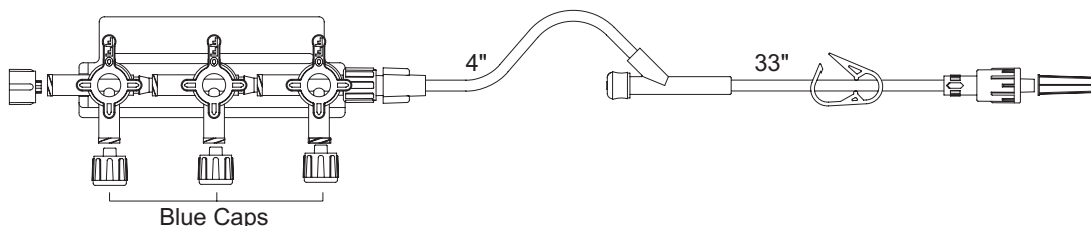

SM5006 50351688500623	Standard Bore Extension with 2 SmartSite® Needle-Free Valves, Pinch Clamp, Slide Swivel Luer Lock	<ul style="list-style-type: none"> • Non-DEHP Formulation • Latex-Free 	1.6 mL	13" (33 cm)	50
---------------------------------	---	--	--------	----------------	----

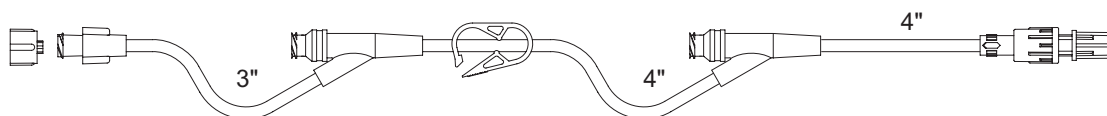

SM5010 50351688500586	Standard Bore Extension, Pinch Clamp, SmartSite® Needle-Free Valve, Slide Swivel Luer Lock	<ul style="list-style-type: none"> • Non-DEHP Formulation • Latex-Free 	3.0 mL	22" (56 cm)	50
---------------------------------	--	--	--------	----------------	----

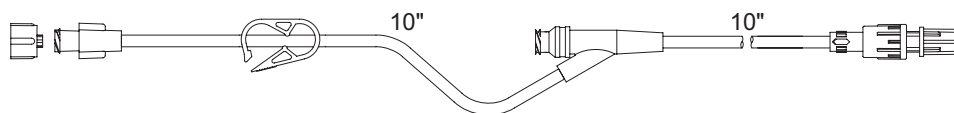

SM5011 50351688500579	Standard Bore Extension with SmartSite® Needle-Free Valve, Non-Removable Blue Slide Clamp, Male Luer Lock	<ul style="list-style-type: none"> • Non-DEHP Formulation • Latex-Free 	0.8 mL	8" (20 cm)	100
---------------------------------	---	--	--------	---------------	-----

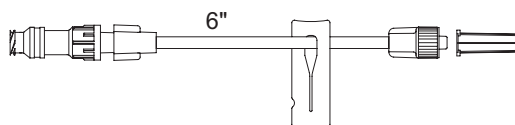

SM5012 50351688500562	Standard Bore Extension with 2 SmartSite® Needle-Free Valves, Pinch Clamp, Slide Swivel Luer Lock	<ul style="list-style-type: none"> • Non-DEHP Formulation • Latex-Free 	4.0 mL	30" (76 cm)	50
---------------------------------	---	--	--------	----------------	----

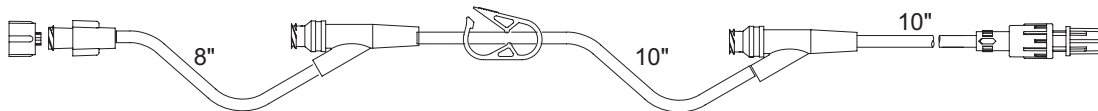

SM5020 50351688500548	Standard Bore Extension with 0.2 Micron Filter, Pinch Clamp, SmartSite® Needle-Free Valve, Slide Swivel Luer Lock	<ul style="list-style-type: none"> • Non-DEHP Formulation • Latex-Free • Low Protein Binding Filter 	3.1 mL	20" (51 cm)	25
---------------------------------	---	--	--------	----------------	----

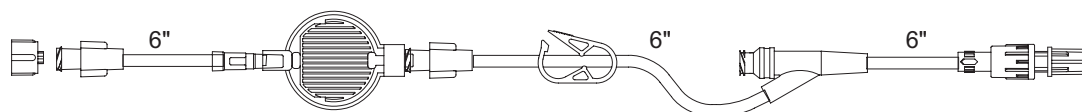

Standard Bore

PRODUCT CODE/UPC	DESCRIPTION	FEATURES	APPROX. PRIMING VOLUME	APPROX. OVERALL LENGTH	UNITS PER CASE
SM5021 50351688500531	Standard Bore Extension with 1.2 Micron Filter, Pinch Clamp, SmartSite® Needle-Free Valve, Slide Swivel Luer Lock	<ul style="list-style-type: none"> • Non-DEHP Formulation • Latex-Free • Low Protein Binding Filter 	3.0 mL	20" (51 cm)	25

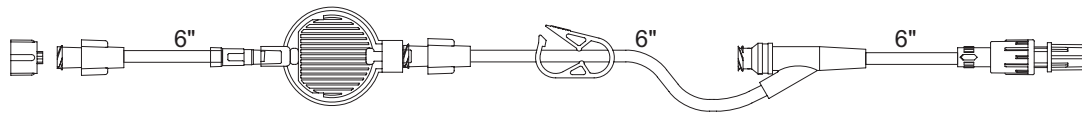

SM5024 50351688500524	Standard Bore Extension with Pinch Clamps, 2 SmartSite® Needle-Free Valves, Slide Swivel Luer Lock	<ul style="list-style-type: none"> • Non-DEHP Formulation • Latex-Free 	4.7 mL	40" (102 cm)	25
---------------------------------	--	--	--------	-----------------	----

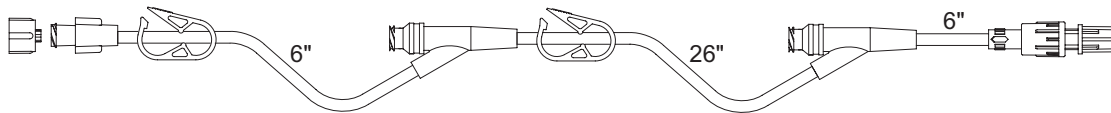

SM7223SC 50351688500487	3-Gang Large Bore 4-Way Hi-Flo™ Manifold with Non-Vented Blue Caps on Middle Ports, Detachable Standard Bore Extension, SmartSite® Needle-Free Valve, Pinch Clamp, Slide Swivel Male Luer Lock	<ul style="list-style-type: none"> • Non-DEHP Formulation • Latex-Free 	5.6 mL	42" (107 cm)	25
-----------------------------------	--	--	--------	-----------------	----

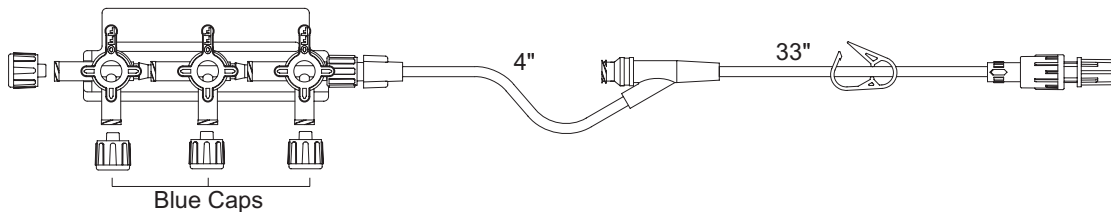

SM924SL 50351688500401	4-Way Large Bore Hi-Flo™ Stopcock with Non-Vented Blue Cap on Middle Port, Standard Bore Extension, SmartSite® Needle-Free Valve, Slide Swivel Luer Lock	<ul style="list-style-type: none"> • Non-DEHP Formulation • Latex-Free 	4.6 mL	39" (99 cm)	50
----------------------------------	--	--	--------	----------------	----

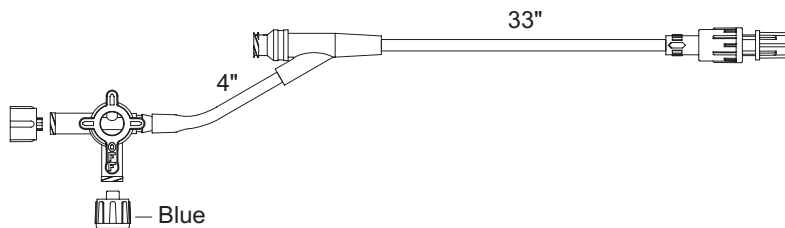

Small Bore

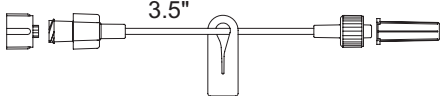
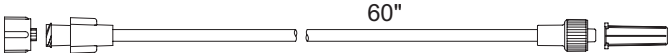
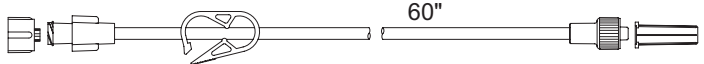
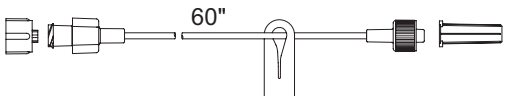
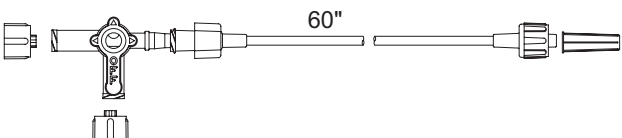
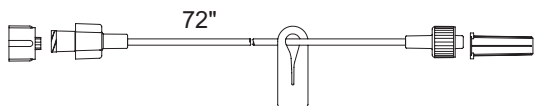
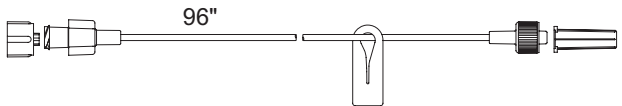
PRODUCT CODE/UPC	DESCRIPTION	FEATURES	APPROX. PRIMING VOLUME	APPROX. OVERALL LENGTH	UNITS PER CASE
53035 50351688516464	Small Bore Extension with Non-Removable Blue Slide Clamp, Male Luer Lock	<ul style="list-style-type: none"> • Non-DEHP Formulation • Latex-Free 	0.2 mL	5" (13 cm)	50
					
5360225 50351688516372	Small Bore Extension with Male Luer Lock	<ul style="list-style-type: none"> • DEHP Formulation • Latex-Free 	2.4 mL	60" (152 cm)	25
					
5360225C 50351688516365	Small Bore Extension with Pinch Clamp, Male Luer Lock	<ul style="list-style-type: none"> • DEHP Formulation • Latex-Free 	2.4 mL	60" (152 cm)	25
					
536035 50351688516358	Small Bore Extension with Non-Removable Blue Slide Clamp, Male Luer Lock	<ul style="list-style-type: none"> • Non-DEHP Formulation • Latex-Free 	1.1 mL	61" (155 cm)	50
					
5360355C 50351688516341	Small Bore 3-Way Stopcock Extension with Male Luer Lock	<ul style="list-style-type: none"> • Non-DEHP Formulation • Latex-Free 	1.3 mL	63" (160 cm)	25
					
537235C 50351688516297	Small Bore Extension with Non-Removable Blue Slide Clamp, Male Luer Lock	<ul style="list-style-type: none"> • Non-DEHP Formulation • Latex-Free 	1.3 mL	72" (183 cm)	50
					
539635 50351688516266	Small Bore Extension with Non-Removable Blue Slide Clamp, Male Luer Lock	<ul style="list-style-type: none"> • Non-DEHP Formulation • Latex-Free 	1.6 mL	96" (244 cm)	50
					

Small Bore

PRODUCT CODE/UPC	DESCRIPTION	FEATURES	APPROX. PRIMING VOLUME	APPROX. OVERALL LENGTH	UNITS PER CASE
BF100 50351688511988	Small Bore Bifurcated Extension with Color-Coded Pinch Clamps, 1 Non-Vented White Cap, Male Luer Lock	<ul style="list-style-type: none"> • DEHP Formulation • Latex-Free 	0.6 mL	7" (18 cm)	25

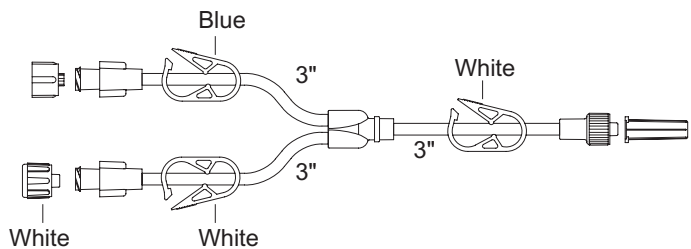

BF13 50351688511971	Small Bore Bifurcated Extension with Color-Coded Pinch Clamps, 1 Back Check Valve, Male Luer Lock	<ul style="list-style-type: none"> • DEHP Formulation • Latex-Free 	0.6 mL	7" (18 cm)	25
-------------------------------	---	--	--------	------------	----

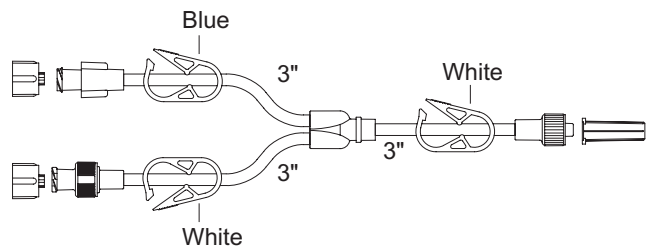

BTF36 50351688511605	Small Bore Trifurcated Extension with 2 Back Check Valves, Non-Removable Blue Slide Clamps, Swivel Male Luer Lock	<ul style="list-style-type: none"> • Non-DEHP Formulation • Latex-Free 	0.4 mL	4" (10 cm)	25
--------------------------------	---	--	--------	------------	----

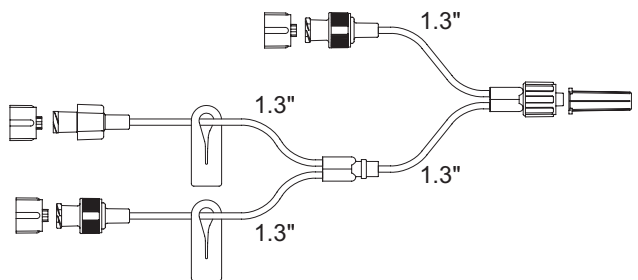

FS113 50351688510981	Small Bore Trifurcated Extension with 0.2 Micron Filter, Color-Coded Non-Removable Slide Clamps, Male Luer Lock	<ul style="list-style-type: none"> • Non-DEHP Formulation • Latex-Free • Low Protein Binding Filter 	0.9 mL	13" (33 cm)	25
--------------------------------	---	--	--------	-------------	----

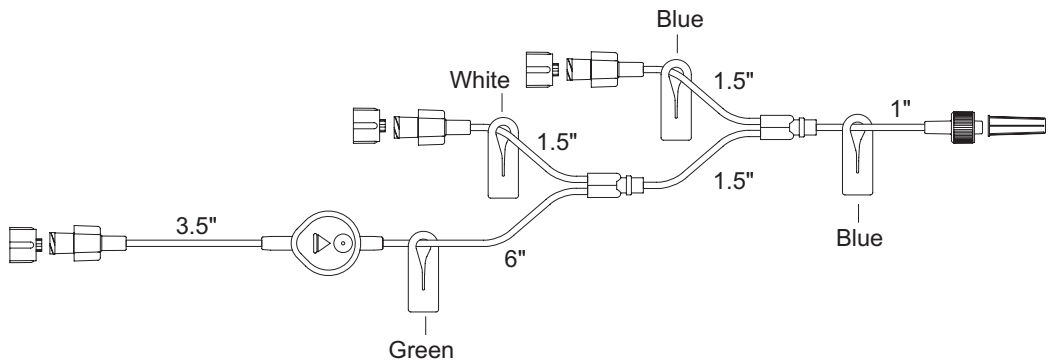

Small Bore

PRODUCT CODE/UPC	DESCRIPTION	FEATURES	APPROX. PRIMING VOLUME	APPROX. OVERALL LENGTH	UNITS PER CASE
MBF27 50351688510479	Small Bore Extension with Non-Removable Blue Slide Clamps, 1 Non-Vented White Cap, Swivel Male Luer Lock	<ul style="list-style-type: none"> • Non-DEHP Formulation • Latex-Free 	0.4 mL	5" (13 cm)	25
MBF30 50351688510448	Small Bore Bifurcated Extension with Non-Removable Blue Slide Clamps, 1 Non-Vented White Cap, Male Luer Lock	<ul style="list-style-type: none"> • Non-DEHP Formulation • Latex-Free 	0.4 mL	6" (15 cm)	25
MTF37 50351688510325	Small Bore Trifurcated Extension with Non-Removable Blue Slide Clamps, 2 Non-Vented White Caps, Swivel Male Luer Lock	<ul style="list-style-type: none"> • Non-DEHP Formulation • Latex-Free 	0.5 mL	4" (10 cm)	25
MX20194 50351688509688	Small Bore Extension with Pinch Clamp, Male Luer Lock	<ul style="list-style-type: none"> • Non-DEHP Formulation • Latex-Free 	6.5 mL	240" (609 cm)	25
MX43660 50351688507561	Small Bore 3-Way Stopcock Extension, Male Luer Lock	<ul style="list-style-type: none"> • Non-DEHP Formulation • Latex-Free 	0.4 mL	8" (20 cm)	25
MX43661 50351688507554	Small Bore 3-Way Stopcock Extension, Male Luer Lock	<ul style="list-style-type: none"> • Non-DEHP Formulation • Latex-Free 	0.5 mL	14" (36 cm)	25

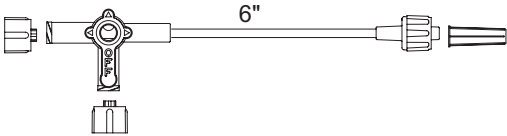
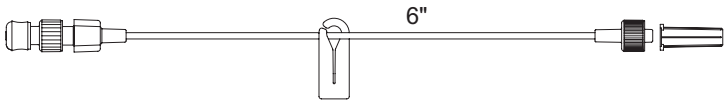
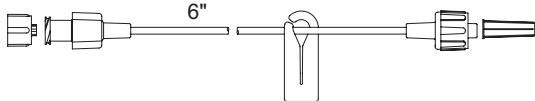
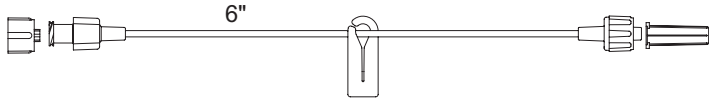
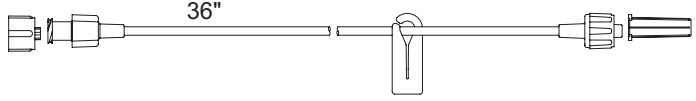
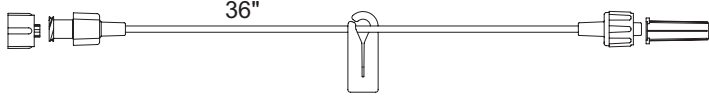
Small Bore					
PRODUCT CODE/UPC	DESCRIPTION	FEATURES	APPROX. PRIMING VOLUME	APPROX. OVERALL LENGTH	UNITS PER CASE
MX43860 50351688507530	Small Bore 4-Way Stopcock Extension, Male Luer Lock	<ul style="list-style-type: none"> • Non-DEHP Formulation • Latex-Free 	0.4 mL	8" (20 cm)	25
					
MX448A 50351688507486	Small Bore Extension with Detachable Injection Site, Removable Blue Slide Clamp, Male Luer Lock	<ul style="list-style-type: none"> • Non-DEHP Formulation • Fluid Path • Latex-Free 	0.3 mL	7" (18 cm)	50
					
MX448HL 50351688507448	Ultra™ Small Bore Extension, Removable Slide Clamp, Male Luer Lock	<ul style="list-style-type: none"> • Non-DEHP Formulation • Latex-Free • Lipid Resistant • Non-PVC 	0.3 mL	7" (18 cm)	50
					
MX448L 50351688507400	Small Bore Extension with Removable Blue Slide Clamp, Male Luer Lock	<ul style="list-style-type: none"> • Non-DEHP Formulation • Latex-Free 	0.3 mL	7" (18 cm)	50
					
MX448HL36 50351688507431	Ultra™ Small Bore Extension with Removable Slide Clamp, Male Luer Lock	<ul style="list-style-type: none"> • Non-DEHP Formulation • Latex-Free • Lipid Resistant • Non-PVC 	1.1 mL	37" (94 cm)	50
					
MX448L36 50351688507394	Small Bore Extension with Removable Blue Slide Clamp, Male Luer Lock	<ul style="list-style-type: none"> • Non-DEHP Formulation • Latex-Free 	1.0 mL	36" (91 cm)	50
					

Small Bore

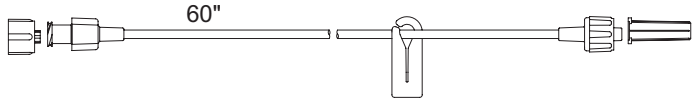
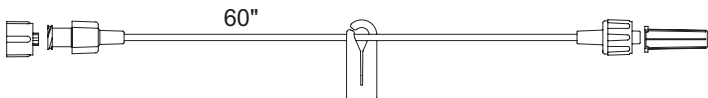
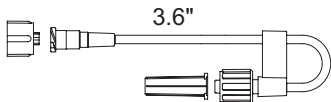
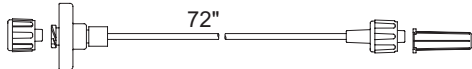
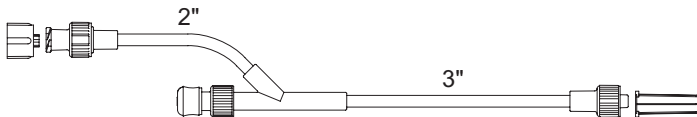
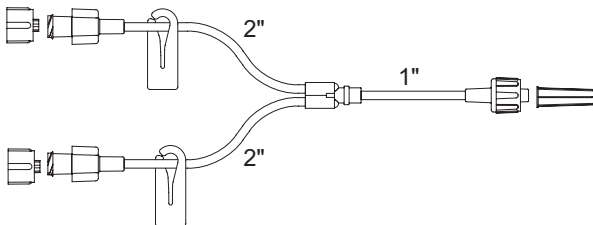
PRODUCT CODE/UPC	DESCRIPTION	FEATURES	APPROX. PRIMING VOLUME	APPROX. OVERALL LENGTH	UNITS PER CASE
MX448HL60 50351688507424	Ultra™ Small Bore Extension with Removable Slide Clamp, Male Luer Lock	<ul style="list-style-type: none"> • Non-DEHP Formulation • Latex-Free • Lipid Resistant • Non-PVC 	1.7 mL	60" (152 cm)	50
					
MX448L60 50351688507387	Small Bore Extension with Removable Blue Slide Clamp, Male Luer Lock	<ul style="list-style-type: none"> • Non-DEHP Formulation • Latex-Free 	1.8 mL	60" (152 cm)	50
					
MX457L 50351688507097	Small Bore Extension with Swivel Male Luer Lock	<ul style="list-style-type: none"> • Non-DEHP Formulation • Latex-Free 	0.3 mL	4" (10 cm)	50
					
MX580 50351688506403	Small Bore Tamper Resistant Extension with Male Luer Lock	<ul style="list-style-type: none"> • DEHP Formulation • Latex-Free 	1.2 mL	70" (178 cm)	50
					
MX581 50351688506397	Small Bore Anti-Reflux Extension with Back Check Valve, Detachable Injection Site, Male Luer Lock	<ul style="list-style-type: none"> • DEHP Formulation • Latex-Free 	0.5 mL	7" (18 cm)	50
					
MX612H 50351688506311	Ultra™ Small Bore Bifurcated Extension with Removable Slide Clamps, Male Luer Lock	<ul style="list-style-type: none"> • Non-DEHP Formulation • Latex-Free • Lipid Resistant • Non-PVC 	0.4 mL	4" (10 cm)	50
					

Small Bore

PRODUCT CODE/UPC	DESCRIPTION	FEATURES	APPROX. PRIMING VOLUME	APPROX. OVERALL LENGTH	UNITS PER CASE
MX613H 50351688506298	Ultra™ Small Bore Trifurcated Extension with Removable Slide Clamps, Male Luer Lock	<ul style="list-style-type: none"> • Non-DEHP Formulation • Latex-Free • Lipid Resistant • Non-PVC 	0.5 mL	4" (10 cm)	50

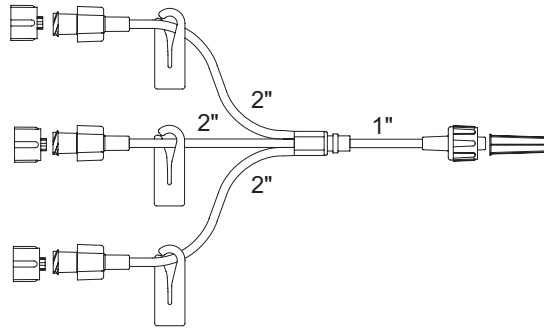

QF140 50351688500784	Small Bore Quad Extension with Non-Removable Blue Slide Clamps, 2 Non-Vented White Caps, Male Luer Lock	<ul style="list-style-type: none"> • Non-DEHP Formulation • Latex-Free 	0.6 mL	7" (18 cm)	25
--------------------------------	---	--	--------	---------------	----

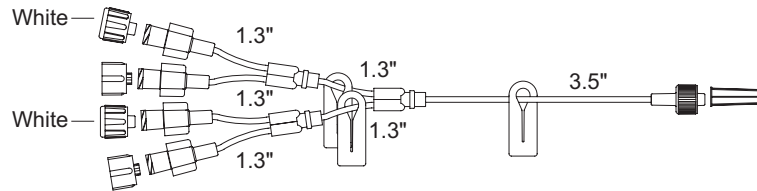

SM5001 50351688500678	Small Bore Extension with SmartSite® Needle-Free Valve, Non-Removable Blue Slide Clamp, Slide Swivel Luer Lock	<ul style="list-style-type: none"> • Non-DEHP Formulation • Latex-Free 	0.3 mL	9" (23 cm)	100
---------------------------------	--	--	--------	---------------	-----

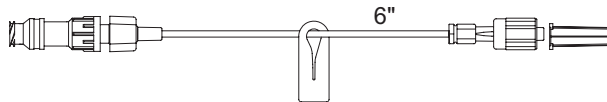

SM5002 50351688500661	Small Bore Extension with SmartSite® Needle-Free Valve, Non-Removable Blue Slide Clamp, Male Luer Lock	<ul style="list-style-type: none"> • Non-DEHP Formulation • Latex-Free 	0.3 mL	8" (20 cm)	100
---------------------------------	--	--	--------	---------------	-----

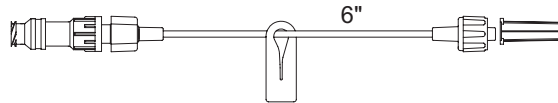

SM5003 50351688500654	Small Bore Bifurcated Extension, 2 SmartSite® Needle-Free Valves, Non-Removable Blue Slide Clamps, Male Luer Lock	<ul style="list-style-type: none"> • Non-DEHP Formulation • Latex-Free 	0.4 mL	5" (13 cm)	100
---------------------------------	---	--	--------	---------------	-----

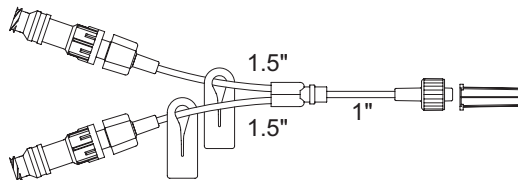

Small Bore

PRODUCT CODE/UPC	DESCRIPTION	FEATURES	APPROX. PRIMING VOLUME	APPROX. OVERALL LENGTH	UNITS PER CASE
SM5004 50351688500647	Small Bore Extension with SmartSite® Needle-Free Valve, Swivel Male Luer Lock	<ul style="list-style-type: none"> • Non-DEHP Formulation • Latex-Free 	0.3 mL	6" (15 cm)	100

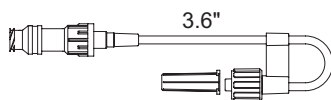

SM5014 50351688500555	Small Bore Trifurcated Extension with Non-Removable Blue Slide Clamps, 3 SmartSite® Needle-Free Valves, Male Luer Lock	<ul style="list-style-type: none"> • Non-DEHP Formulation • Latex-Free 	0.7 mL	5" (13 cm)	100
---------------------------------	--	--	--------	---------------	-----

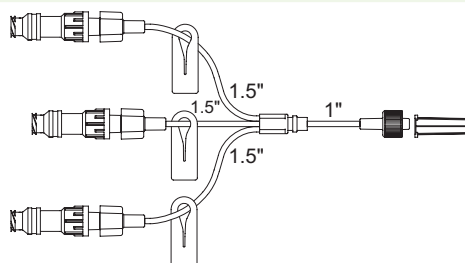

TF55 50351688500319	Small Bore Trifurcated Extension, 2 Non-Vented White Caps, Color-Coded Pinch Clamps, Male Luer Lock	<ul style="list-style-type: none"> • DEHP Formulation • Latex-Free 	0.8 mL	7" (18 cm)	25
-------------------------------	---	--	--------	---------------	----

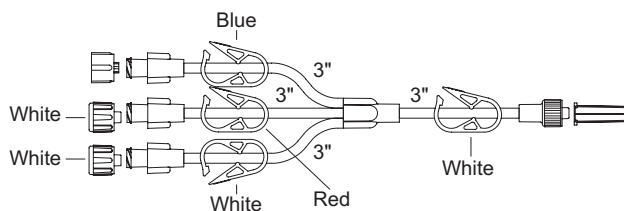

TF56 50351688500302	Small Bore Trifurcated Extension, 2 Non-Vented White Caps, Color-Coded Pinch Clamps, Male Luer Lock	<ul style="list-style-type: none"> • Non-DEHP Formulation • Latex-Free 	0.6 mL	9" (23 cm)	25
-------------------------------	---	--	--------	---------------	----

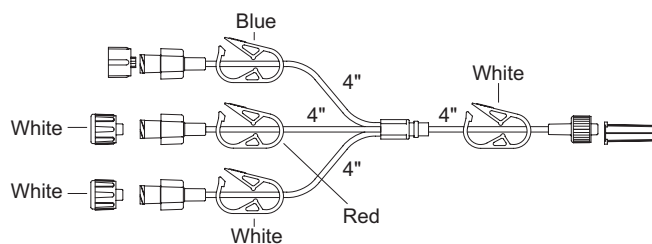

BBF26 50351688512015	Small Bore Extension, 1 Back Check Valve, Non-Removable Blue Slide Clamps, Swivel Male Luer Lock	<ul style="list-style-type: none"> • Non-DEHP Formulation • Latex-Free 	0.3 mL	5" (13 cm)	25
--------------------------------	--	--	--------	---------------	----

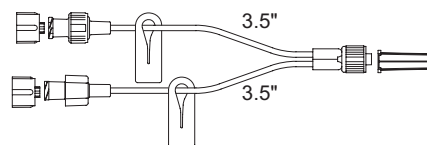

Small Bore Light Resistant Tubing

PRODUCT CODE/UPC	DESCRIPTION	FEATURES	APPROX. PRIMING VOLUME	APPROX. OVERALL LENGTH	UNITS PER CASE
537235PS 50351688516280	Small Bore Light Resistant Extension, Non-Removable Blue Slide Clamp, Male Luer Lock	<ul style="list-style-type: none"> • Non-DEHP Formulation Fluid Path • Latex-Free • Polyethylene Lined Tubing 	1.3 mL	72" (183 cm)	50

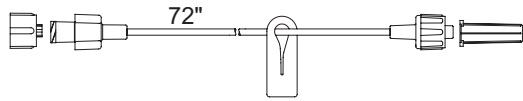

Small Bore T-Connectors

PRODUCT CODE/UPC	DESCRIPTION	FEATURES	APPROX. PRIMING VOLUME	APPROX. OVERALL LENGTH	UNITS PER CASE
MX453H2L 50351688507202	Ultra™ Small Bore Bifurcated T-Connector Extension with Injection Site, Removable Slide Clamps, Swivel Male Luer Lock	<ul style="list-style-type: none"> • Non-DEHP Formulation • Latex-Free • Lipid Resistant • Non-PVC 	0.5 mL	5" (13 cm)	50

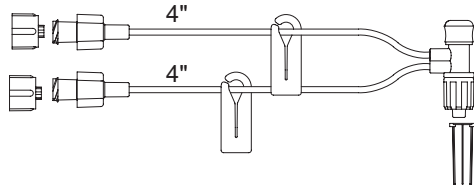

MX453HL 50351688507196	Ultra™ Small Bore T-Connector with Injection Site, Removable Slide Clamp, Swivel Male Luer Lock	<ul style="list-style-type: none"> • Non-DEHP Formulation • Latex-Free • Lipid Resistant • Non-PVC 	0.4 mL	7" (18 cm)	50
----------------------------------	---	--	--------	---------------	----

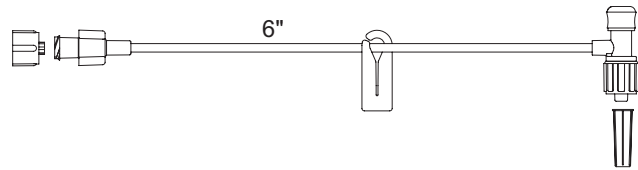

MX453SL 50351688507172	Small Bore T-Connector with Injection Site, Removable Blue Slide Clamp, Swivel Male Luer	<ul style="list-style-type: none"> • Non-DEHP Formulation • Latex-Free 	0.4 mL	7" (18 cm)	50
----------------------------------	--	--	--------	---------------	----

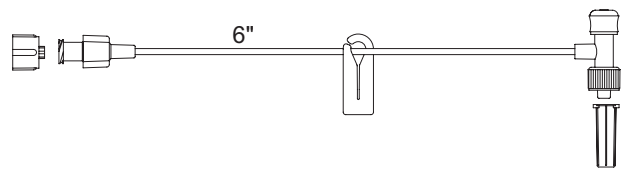

Small Bore T-Connectors

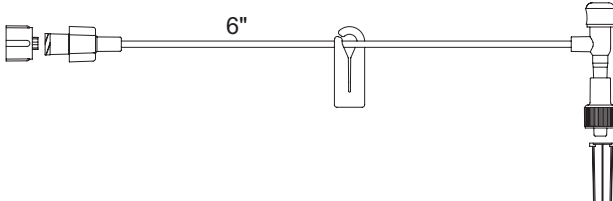
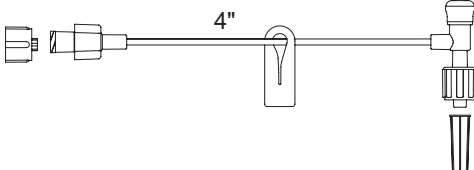
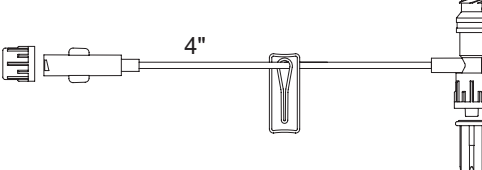
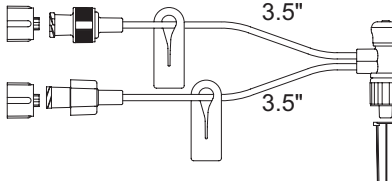
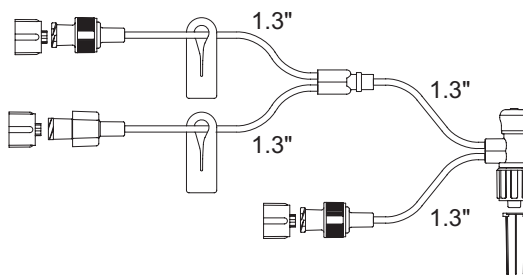
PRODUCT CODE/UPC	DESCRIPTION	FEATURES	APPROX. PRIMING VOLUME	APPROX. OVERALL LENGTH	UNITS PER CASE
MX453L 50351688507189	Small Bore T-Connector Extension, Removable Blue Slide Clamp, Male Luer Lock	<ul style="list-style-type: none"> • DEHP Formulation • Latex-Free 	0.4 mL	7" (18 cm)	50
					
MX459SL 50351688507059	Small Bore T-Connector with Injection Site, Non-Removable Slide Clamp, Swivel Male Luer	<ul style="list-style-type: none"> • Non-DEHP Formulation Fluid Path • Latex-Free 	0.3 mL	5" (13 cm)	50
					
SM5008 50351688500609	Small Bore T-Connector Extension with SmartSite® Needle-Free Valve, Non-Removable Slide Clamp, Swivel Luer Lock	<ul style="list-style-type: none"> • Non-DEHP Formulation • Latex-Free 	0.2 mL	5" (13 cm)	100
					
BBF26DTL 50351688512008	Small Bore Bifurcated T-Connector Extension with Injection Site, 1 Back Check Valve, Non-Removable Blue Slide Clamps, Swivel Male Luer	<ul style="list-style-type: none"> • Non-DEHP Formulation Fluid Path • Latex-Free 	0.4 mL	4" (10 cm)	25
					
BTF36DTL 50351688511599	Small Bore Trifurcated T-Connector Extension with Injection Site, 2 Back Check Valves, Non-Removable Blue Slide Clamps, Swivel Male Luer	<ul style="list-style-type: none"> • Non-DEHP Formulation Fluid Path • Latex-Free 	0.4 mL	4" (10 cm)	25
					

Small Bore T-Connectors

PRODUCT CODE/UPC	DESCRIPTION	FEATURES	APPROX. PRIMING VOLUME	APPROX. OVERALL LENGTH	UNITS PER CASE
MBF27DTL 50351688510462	Small Bore Bifurcated T-Connector Extension with Injection Site, Blue Slide Clamps, Non-Vented White Cap, Swivel Male Luer	<ul style="list-style-type: none"> • Non-DEHP Formulation Fluid Path • Latex-Free 	0.4 mL	4" (10 cm)	25

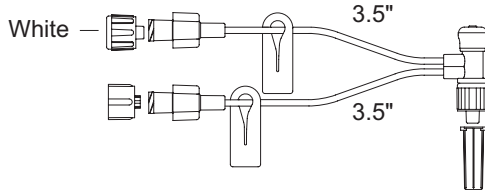

MBF29DTL 50351688510455	Small Bore Bifurcated T-Connector Extension, Color-Coded Pinch Clamps, Female Port, 2 Non-Vented White Caps, Swivel Luer Lock	<ul style="list-style-type: none"> • Non-DEHP Formulation • Latex-Free 	0.4 mL	4" (10 cm)	25
-----------------------------------	---	--	--------	------------	----

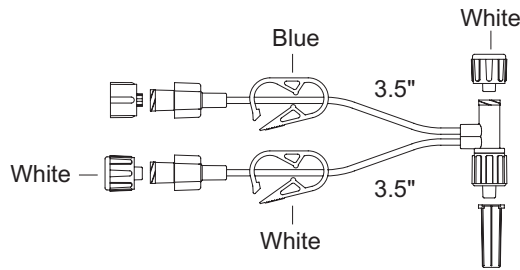

MTF37DTL 50351688510318	Small Bore Trifurcated T-Connector Extension with Injection Site, Non-Removable Blue Slide Clamps, 2 Non-Vented White Caps, Swivel Male Luer	<ul style="list-style-type: none"> • Non-DEHP Formulation Fluid Path • Latex-Free 	0.5 mL	4" (10 cm)	25
-----------------------------------	--	---	--------	------------	----

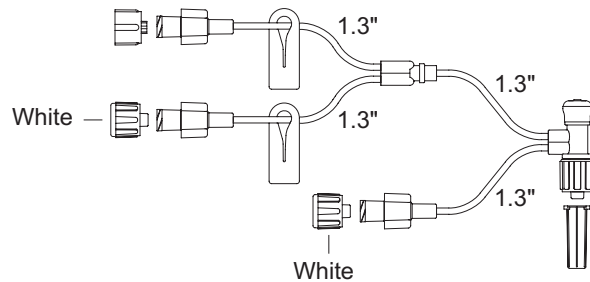

Micro Bore

PRODUCT CODE/UPC	DESCRIPTION	FEATURES	APPROX. PRIMING VOLUME	APPROX. OVERALL LENGTH	UNITS PER CASE
533640 50351688516426	Micro Bore Extension with Male Luer Lock	<ul style="list-style-type: none"> • Non-DEHP Formulation • Latex-Free 	0.2 mL	37" (94 cm)	50

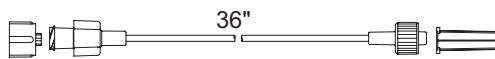

533640C 50351688516419	Micro Bore Extension with Male Luer Lock, Non-Removable Slide Clamp	<ul style="list-style-type: none"> • Non-DEHP Formulation • Latex-Free 		36" (91 cm)	50
----------------------------------	---	--	--	-------------	----

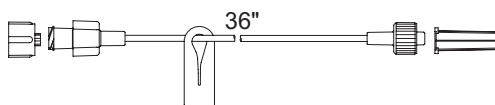

Micro Bore

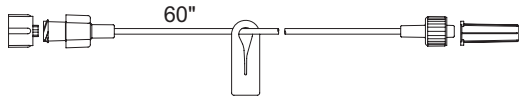
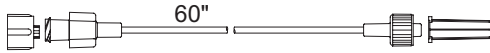
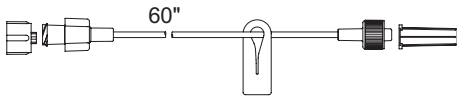
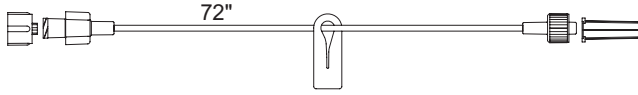
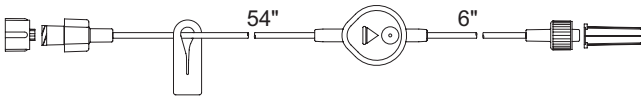
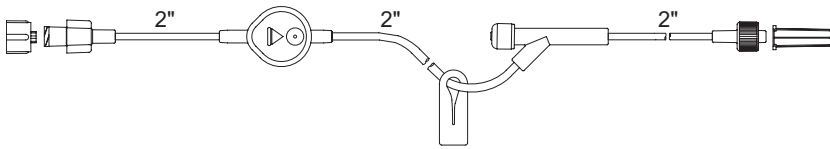
PRODUCT CODE/UPC	DESCRIPTION	FEATURES	APPROX. PRIMING VOLUME	APPROX. OVERALL LENGTH	UNITS PER CASE
536020 50351688516396	Micro Bore Extension with Non-Removable Green Slide Clamp, Male Luer Lock	<ul style="list-style-type: none"> • Non-DEHP Formulation • Latex-Free 	0.4 mL	60" (152 cm)	50
					
536040 50351688516334	Micro Bore Extension with Male Luer Lock	<ul style="list-style-type: none"> • Non-DEHP Formulation • Latex-Free 	0.3 mL	61" (155 cm)	50
					
536040C 50351688516327	Micro Bore Extension with Non-Removable Slide Clamp, Male Luer Lock	<ul style="list-style-type: none"> • Non-DEHP Formulation • Latex-Free 	0.3 mL	61" (155 cm)	50
					
537220 50351688516310	Micro Bore Extension with Non-Removable Green Slide Clamp, Male Luer Lock	<ul style="list-style-type: none"> • Non-DEHP Formulation • Latex-Free 	0.5 mL	72" (183 cm)	50
					
FS116 50351688510967	Micro Bore Extension with 0.2 Micron Filter, Non-Removable Blue Slide Clamp, Male Luer Lock	<ul style="list-style-type: none"> • Non-DEHP Formulation • Latex-Free • Low Protein Binding Filter 	0.7 mL	62" (157 cm)	25
					
FS117 50351688510950	Micro Bore Extension with 0.2 Micron Filter, Non-Removable Blue Slide Clamp, "Y" Injection Site, Male Luer Lock	<ul style="list-style-type: none"> • Non-DEHP Formulation Fluid Path • Latex-Free • Low Protein Binding Filter 	0.5 mL	8" (20 cm)	25
					

Micro Bore Light Resistant Tubing

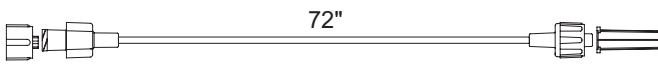
PRODUCT CODE/UPC	DESCRIPTION	FEATURES	APPROX. PRIMING VOLUME	APPROX. OVERALL LENGTH	UNITS PER CASE
537240PS 50351688516273	Micro Bore Light Resistant Extension, Male Luer Lock	<ul style="list-style-type: none"> • Non-DEHP Formulation Fluid Path • Latex-Free • Polyethylene Lined Tubing 	0.3 mL	72" (183 cm)	50
					

Non-PVC Ultra™ Small Bore Extension Sets



Ultra™ Small Bore Extension Sets

p3534

Ultra™ Small Bore Extensions

PRODUCT CODE/UPC	DESCRIPTION	FEATURES	APPROX. PRIMING VOLUME	APPROX. OVERALL LENGTH	UNITS PER CASE
MX448HF 50351688507462	Ultra™ Small Bore Extension with 0.2 Micron Filter and Removable Slide Clamp, Male Luer Lock	<ul style="list-style-type: none"> • Non-DEHP Formulation • Latex-Free • Lipid Resistant • Non-PVC • Low Protein Binding Filter 	1.0 mL	7" (18 cm)	50

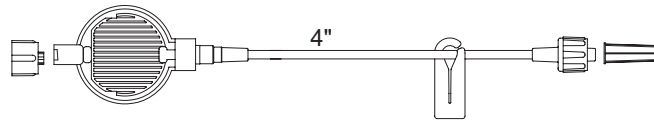

MX448HFB 50351688507455	Ultra™ Small Bore Extension with 1.2 Micron Filter and Removable Slide Clamp, Male Luer Lock	<ul style="list-style-type: none"> • Non-DEHP Formulation • Latex-Free • Lipid Resistant • Non-PVC • Low Protein Binding Filter 	1.0 mL	7" (18 cm)	50
-----------------------------------	--	--	--------	------------	----

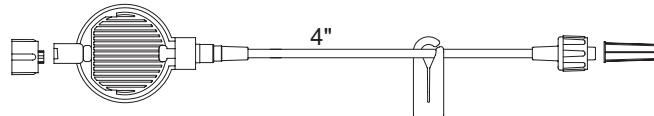

MX448HL 50351688507448	Ultra™ Small Bore Extension, Removable Slide Clamp, Male Luer Lock	<ul style="list-style-type: none"> • Non-DEHP Formulation • Latex-Free • Lipid Resistant • Non-PVC 	0.3 mL	7" (18 cm)	50
----------------------------------	--	--	--------	------------	----

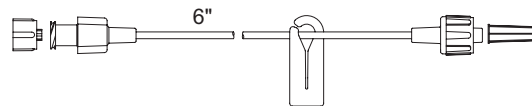

MX448HL36 50351688507431	Ultra™ Small Bore Extension with Removable Slide Clamp, Male Luer Lock	<ul style="list-style-type: none"> • Non-DEHP Formulation • Latex-Free • Lipid Resistant • Non-PVC 	1.1 mL	37" (94 cm)	50
------------------------------------	--	--	--------	-------------	----

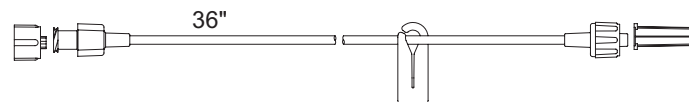

MX448HL60 50351688507424	Ultra™ Small Bore Extension with Removable Slide Clamp, Male Luer Lock	<ul style="list-style-type: none"> • Non-DEHP Formulation • Latex-Free • Lipid Resistant • Non-PVC 	1.7 mL	60" (152 cm)	50
------------------------------------	--	--	--------	--------------	----

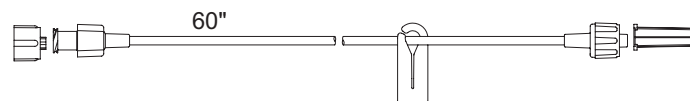

Ultra™ Small Bore Extensions

PRODUCT CODE/UPC	DESCRIPTION	FEATURES	APPROX. PRIMING VOLUME	APPROX. OVERALL LENGTH	UNITS PER CASE
MX612H 50351688506311	Ultra™ Small Bore Bifurcated Extension with Removable Slide Clamps, Male Luer Lock	<ul style="list-style-type: none"> • Non-DEHP Formulation • Latex-Free • Lipid Resistant • Non-PVC 	0.4 mL	4" (10 cm)	50

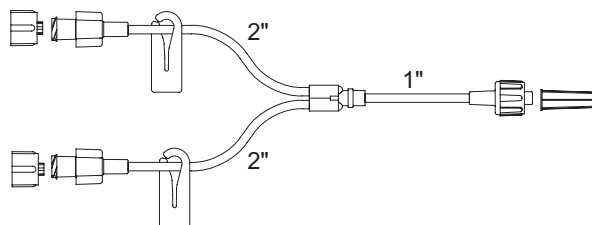

MX613H 50351688506298	Ultra™ Small Bore Trifurcated Extension with Removable Slide Clamps, Male Luer Lock	<ul style="list-style-type: none"> • Non-DEHP Formulation • Latex-Free • Lipid Resistant • Non-PVC 	0.5 mL	4" (10 cm)	50
---------------------------------	---	--	--------	------------	----

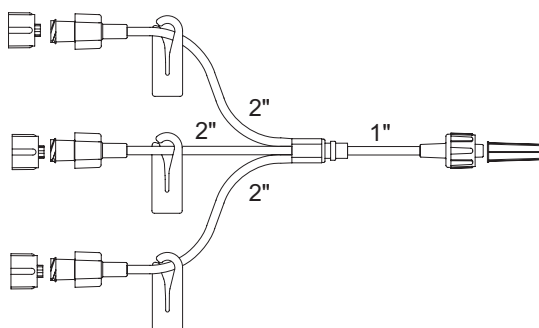

MX453H2L 50351688507202	Ultra™ Small Bore Bifurcated T-Connector Extension with Injection Site, Removable Slide Clamps, Swivel Male Luer Lock	<ul style="list-style-type: none"> • Non-DEHP Formulation • Latex-Free • Lipid Resistant • Non-PVC 	0.5 mL	5" (13 cm)	50
-----------------------------------	---	--	--------	------------	----

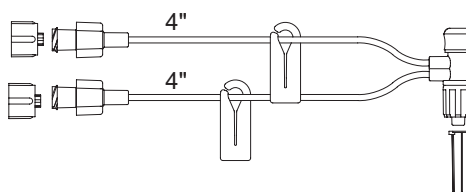

MX453HL 50351688507196	Ultra™ Small Bore T-Connector with Injection Site, Removable Slide Clamp, Swivel Male Luer Lock	<ul style="list-style-type: none"> • Non-DEHP Formulation • Latex-Free • Lipid Resistant • Non-PVC 	0.4 mL	7" (18 cm)	50
----------------------------------	---	--	--------	------------	----

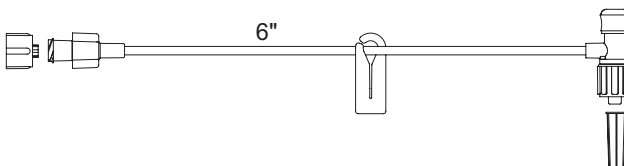



Filter Sets

Ultra™ Small Bore Filter Sets	p40
Filter Sets	p40

Ultra™ Small Bore Filter Sets

PRODUCT CODE/UPC	DESCRIPTION	FEATURES	APPROX. PRIMING VOLUME	APPROX. OVERALL LENGTH	UNITS PER CASE
MX448HF 50351688507462	Ultra™ Small Bore Extension with 0.2 Micron Filter and Removable Slide Clamp, Male Luer Lock	<ul style="list-style-type: none"> • Non-DEHP Formulation • Latex-Free • Lipid Resistant • Non-PVC • Low Protein Binding Filter 	1.0 mL	7" (18 cm)	50

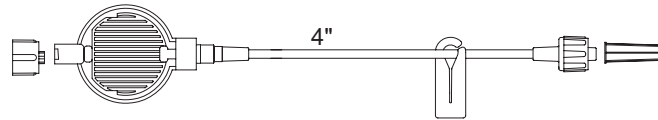

MX448HFB 50351688507455	Ultra™ Small Bore Extension with 1.2 Micron Filter and Removable Slide Clamp, Male Luer Lock	<ul style="list-style-type: none"> • Non-DEHP Formulation • Latex-Free • Lipid Resistant • Non-PVC • Low Protein Binding Filter 	1.0 mL	7" (18 cm)	50
-----------------------------------	--	--	--------	------------	----

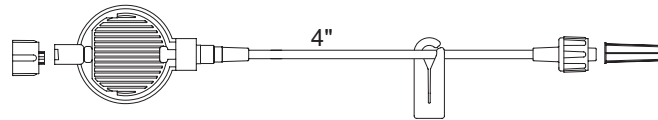

Filter Sets

PRODUCT CODE/UPC	DESCRIPTION	FEATURES	APPROX. PRIMING VOLUME	APPROX. OVERALL LENGTH	UNITS PER CASE
FS113 50351688510981	Small Bore Trifurcated Extension with 0.2 Micron Filter, Color-Coded Non-Removable Slide Clamps, Male Luer Lock	<ul style="list-style-type: none"> • Non-DEHP Formulation • Latex-Free • Low Protein Binding Filter 	0.9 mL	13" (33 cm)	25

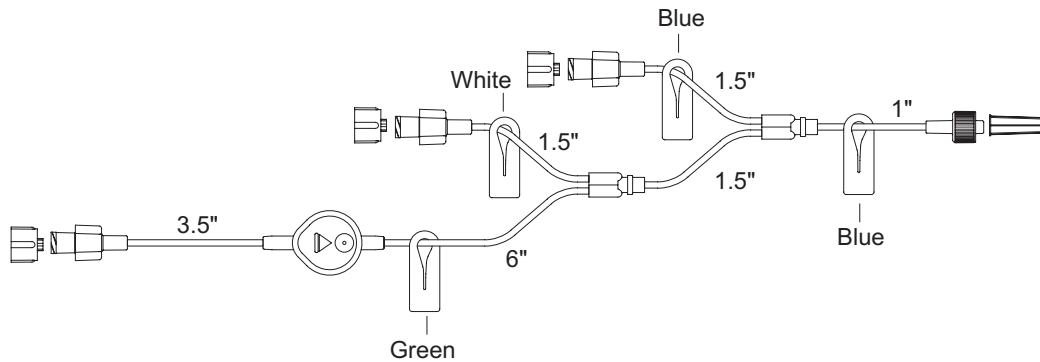

FS116 50351688510967	Micro Bore Extension with 0.2 Micron Filter, Non-Removable Blue Slide Clamp, Male Luer Lock	<ul style="list-style-type: none"> • Non-DEHP Formulation • Latex-Free • Low Protein Binding Filter 	0.7 mL	62" (157 cm)	25
--------------------------------	---	--	--------	--------------	----

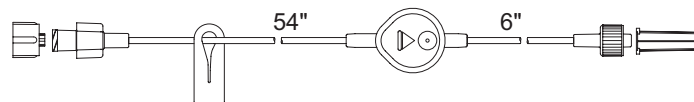

Filter Sets

PRODUCT CODE/UPC	DESCRIPTION	FEATURES	APPROX. PRIMING VOLUME	APPROX. OVERALL LENGTH	UNITS PER CASE
FS117 50351688510950	Micro Bore Extension with 0.2 Micron Filter, Non-Removable Blue Slide Clamp, "Y" Injection Site, Male Luer Lock	<ul style="list-style-type: none"> • Non-DEHP Formulation Fluid Path • Latex-Free • Low Protein Binding Filter 	0.5 mL	8" (20 cm)	25

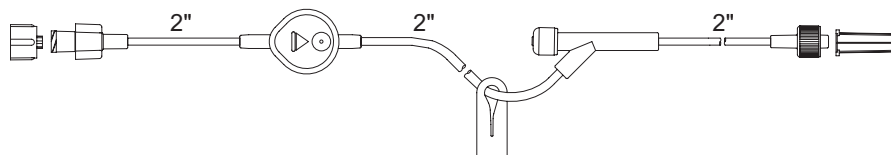

MX448FMG 50351688507479	Vented / Non-Vented Spike Mangum Micro Delivery Administration Set, Pinch Clamp, Back Check Valve, Anti Free-Flow Stopcock, 60" Small Bore Extension, 6" Detachable Extension, 0.2 Micron Filter, Male Luer Lock	<ul style="list-style-type: none"> • Non-DEHP Formulation • Latex-Free • Low Protein Binding Filter 	3.0 mL	74" (188 cm)	25
-----------------------------------	--	--	--------	-----------------	----

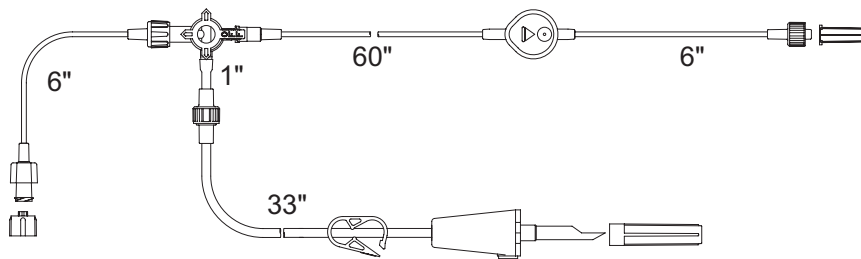

SM5020 50351688500548	Standard Bore Extension with 0.2 Micron Filter, Pinch Clamp, SmartSite® Needle-Free Valve, Slide Swivel Luer Lock	<ul style="list-style-type: none"> • Non-DEHP Formulation • Latex-Free • Low Protein Binding Filter 	3.1 mL	20" (51 cm)	25
---------------------------------	---	--	--------	----------------	----

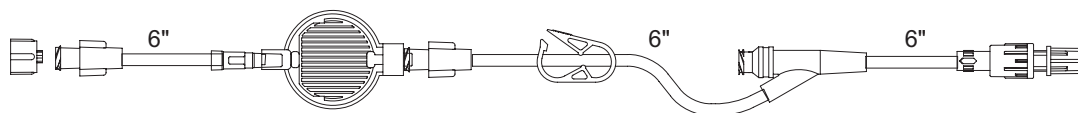

SM5021 50351688500531	Standard Bore Extension with 1.2 Micron Filter, Pinch Clamp, SmartSite® Needle-Free Valve, Slide Swivel Luer Lock	<ul style="list-style-type: none"> • Non-DEHP Formulation • Latex-Free • Low Protein Binding Filter 	3.0 mL	20" (51 cm)	25
---------------------------------	---	--	--------	----------------	----

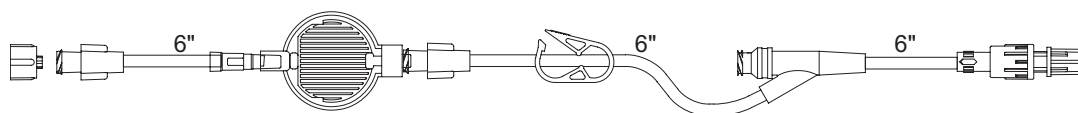

Stopcocks



Small Bore (rated to 45 PSI)	p44
Large Bore Hi-Flo™ (rated to 45 PSI)	p45

Small Bore

PRODUCT CODE/UPC	DESCRIPTION	FEATURES	UNITS PER CASE
MX2311L 50351688508339	3-Way Stopcock with Swivel Male Luer Lock	<ul style="list-style-type: none"> • Non-DEHP Formulation • Latex-Free • Lipid Resistant • Non-PVC 	50

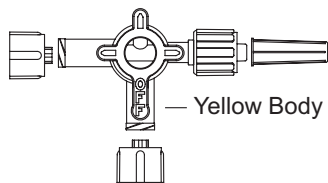

MX2341L 50351688508322	4-Way Stopcock with Swivel Male Luer Lock, Non-Vented Blue Cap on Middle Port	<ul style="list-style-type: none"> • Non-DEHP Formulation • Latex-Free • Lipid Resistant • Non-PVC 	50
----------------------------------	---	--	----

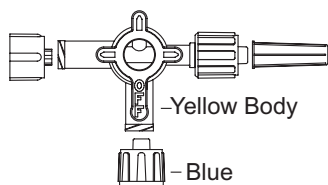

MX5061L 50351688506847	1-Way Stopcock with Swivel Male Luer Lock	<ul style="list-style-type: none"> • Non-DEHP Formulation • Latex-Free • Lipid Resistant • Non-PVC 	50
----------------------------------	---	--	----



MX5311L 50351688506793	3-Way Stopcock with Swivel Male Luer Lock	<ul style="list-style-type: none"> • Non-DEHP Formulation • Latex-Free • Lipid Resistant • Non-PVC 	50
----------------------------------	---	--	----

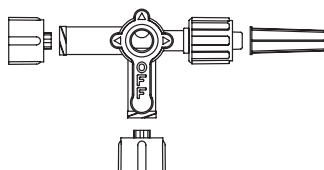

MX5341L 50351688506786	4-Way Stopcock with Swivel Male Luer Lock	<ul style="list-style-type: none"> • Non-DEHP Formulation • Latex-Free • Lipid Resistant • Non-PVC 	50
----------------------------------	---	--	----

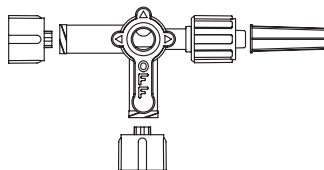

MX5341LN 50351688506779	4-Way Stopcock, Swivel Male Luer Lock, Non-Vented Red Cap on Middle Port	<ul style="list-style-type: none"> • Non-DEHP Formulation • Latex-Free • Lipid Resistant • Non-PVC 	50
-----------------------------------	--	--	----

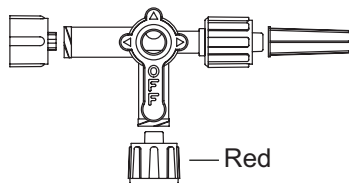

Small Bore

PRODUCT CODE/UPC	DESCRIPTION	FEATURES	UNITS PER CASE
MX5342L 50351688506762	2-Gang, 4-Way Stopcock with Swivel Male Luer Lock	<ul style="list-style-type: none"> • Non-DEHP Formulation • Latex-Free • Lipid Resistant • Non-PVC 	25

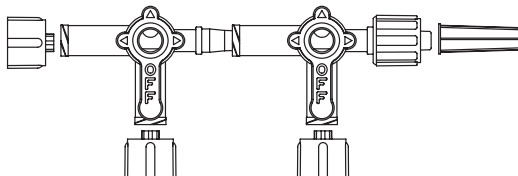

Large Bore - Hi Flo™

PRODUCT CODE/UPC	DESCRIPTION	FEATURES	UNITS PER CASE
MX4312L 50351688507752	2-Gang, 3-Way Hi-Flo™ Stopcock with Extended Male Luer Lock	<ul style="list-style-type: none"> • Non-DEHP Formulation • Latex-Free • Lipid Resistant • Non-PVC 	25

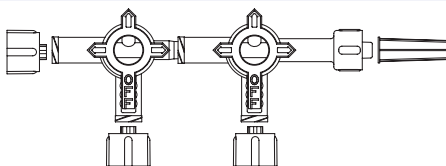

MX4313L 50351688507721	3-Gang, 3-Way Hi-Flo™ Stopcock with Extended Male Luer Lock	<ul style="list-style-type: none"> • Non-DEHP Formulation • Latex-Free • Lipid Resistant • Non-PVC 	25
----------------------------------	---	--	----

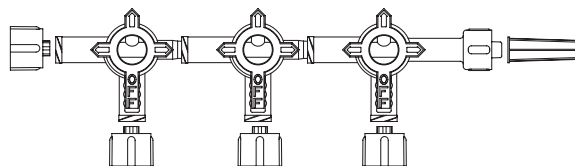

MX4311L 50351688507769	3-Way Hi-Flo™ Stopcock with Extended Male Luer Lock	<ul style="list-style-type: none"> • Non-DEHP Formulation • Latex-Free • Lipid Resistant • Non-PVC 	50
----------------------------------	---	--	----

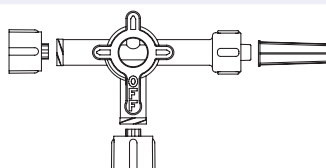

MX4341L 50351688507646	4-Way Hi-Flo™ Stopcock with Extended Male Luer Lock	<ul style="list-style-type: none"> • Non-DEHP Formulation • Latex-Free • Lipid Resistant • Non-PVC 	50
----------------------------------	---	--	----

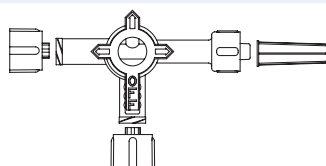

Large Bore - Hi Flo™

PRODUCT CODE/UPC	DESCRIPTION	FEATURES	UNITS PER CASE
MX434B1L 50351688507585	4-Way Hi-Flo™ Stopcock with Blue Handle, Extended Male Luer Lock	<ul style="list-style-type: none"> • Non-DEHP Formulation • Latex-Free • Lipid Resistant • Non-PVC 	50

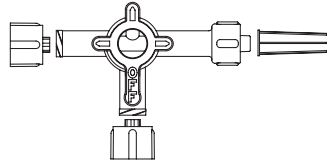

MX9311L 50351688504188	3-Way Hi-Flo™ Stopcock with Swivel Male Luer Lock	<ul style="list-style-type: none"> • Non-DEHP Formulation • Latex-Free • Lipid Resistant • Non-PVC • Yellow Handle 	50
----------------------------------	---	---	----

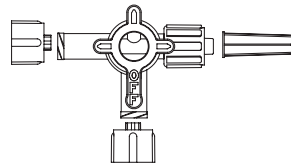

MX9341L 50351688504171	4-Way Hi-Flo™ Stopcock with Swivel Male Luer Lock, Non-Vented Blue Cap on Middle Port	<ul style="list-style-type: none"> • Non-DEHP Formulation • Latex-Free • Lipid Resistant • Non-PVC • Yellow Handle 	50
----------------------------------	---	---	----

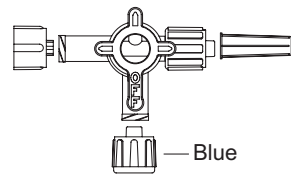

MX9342L 50351688504164	2-Gang, 4-Way Hi-Flo™ Stopcock with Swivel Male Luer Lock	<ul style="list-style-type: none"> • Non-DEHP Formulation • Latex-Free • Lipid Resistant • Non-PVC • Yellow Handles 	25
----------------------------------	---	--	----

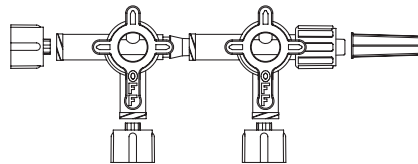

MX4342LM 50351688507639	2-Gang, 4-Way Hi-Flo™ Stopcock Manifold, Extended Male Luer Lock	<ul style="list-style-type: none"> • Non-DEHP Formulation • Latex-Free • Lipid Resistant • Non-PVC 	25
-----------------------------------	--	--	----

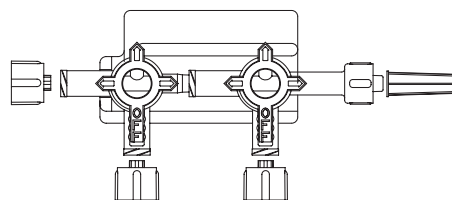

Large Bore - Hi Flo™

PRODUCT CODE/UPC	DESCRIPTION	FEATURES	UNITS PER CASE
MX934Z3LM 50351688504157	3-Gang, 4-Way Hi-Flo™ Stopcock Manifold with Swivel Male Luer Lock, Non-Vented Blue Caps on Middle Ports	<ul style="list-style-type: none"> • Non-DEHP Formulation • Latex-Free • Lipid Resistant • Non-PVC • Yellow Handles 	20

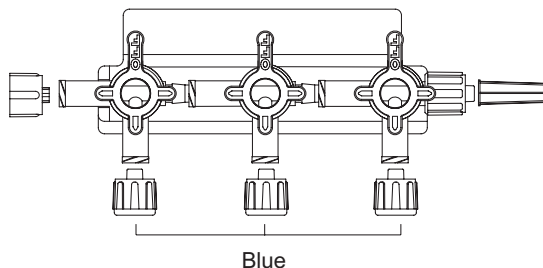

MX4343LM 50351688507615	3-Gang, 4-Way Hi-Flo™ Stopcock Manifold, Extended Male Luer Lock	<ul style="list-style-type: none"> • Non-DEHP Formulation • Latex-Free • Lipid Resistant • Non-PVC 	20
-----------------------------------	--	--	----

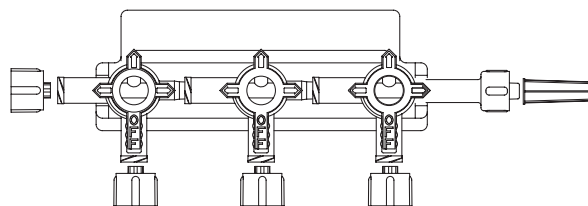

MX934Z4LM 50351688504140	4-Gang, 4-Way Hi-Flo™ Stopcock Manifold with Swivel Male Luer Lock, Non-Vented Blue Caps on Middle Ports	<ul style="list-style-type: none"> • Non-DEHP Formulation • Latex-Free • Lipid Resistant • Non-PVC • Yellow Handles 	20
------------------------------------	--	--	----

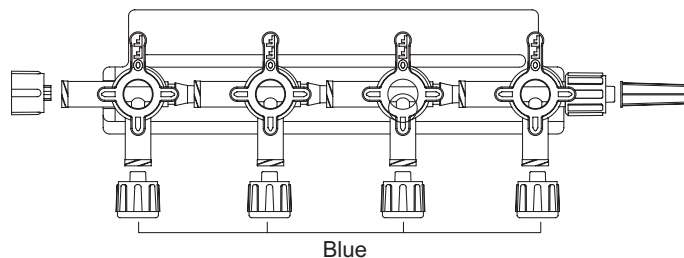

MX4345LM 50351688507592	5-Gang, 4-Way Hi-Flo™ Stopcock Manifold, Extended Male Luer Lock	<ul style="list-style-type: none"> • Non-DEHP Formulation • Latex-Free • Lipid Resistant • Non-PVC 	10
-----------------------------------	--	--	----

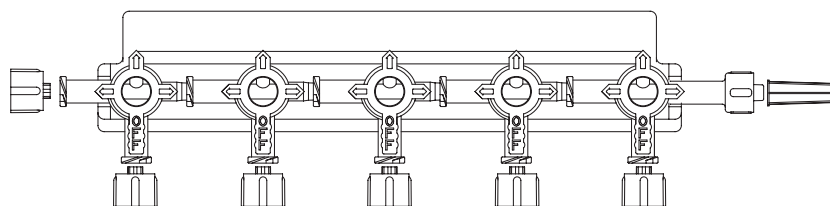



Components

Check Valves	p50
Connectors	p50
Caps	p51
1-Way Valve Medifolds	p52
Injection Sites	p52
Needle-Free Access Systems	p53

Check Valves

PRODUCT CODE/UPC	DESCRIPTION	FEATURES	APPROX. PRIMING VOLUME	APPROX. OVERALL LENGTH	UNITS PER CASE
MX743 50351688505413	Nu-Site® Needle-Free Valve, Non-Vented Blue Cap with Female Luer Lock and Male Luer Lock	<ul style="list-style-type: none"> • Non-DEHP Formulation • Latex-Free 	0.3 mL	1" (3 cm)	100

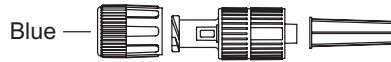

MX745 50351688505406	Mini Duckbill Back Check Valve with Male Luer Lock	<ul style="list-style-type: none"> • Non-DEHP Formulation • Latex-Free • Non-PVC 	0.1 mL	1" (3 cm)	100
--------------------------------	--	---	--------	--------------	-----



Connectors

PRODUCT CODE/UPC	DESCRIPTION	FEATURES	APPROX. PRIMING VOLUME	APPROX. OVERALL LENGTH	UNITS PER CASE
MX301 50351688508049	5 in 1 Connector, Fits 7/32" Diameter to 7/16" Diameter Tubing, Non-Sterile (Autoclavable)	<ul style="list-style-type: none"> • Non-DEHP Formulation • Latex-Free • Non-PVC 	N/A	3" (8 cm)	200 (50/ bag)



MX493 50351688506915	Double Male Luer Lock Adapter	<ul style="list-style-type: none"> • Non-DEHP Formulation • Latex-Free • Lipid Resistant • Non-PVC 	0.1 mL	1" (3 cm)	100
--------------------------------	-------------------------------	--	--------	--------------	-----

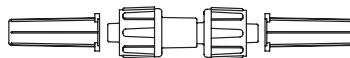

MX494 50351688506908	Double Female Luer Lock Adapter	<ul style="list-style-type: none"> • Non-DEHP Formulation • Latex-Free • Lipid Resistant • Non-PVC 	0.2 mL	2" (5 cm)	100
--------------------------------	---------------------------------	--	--------	--------------	-----

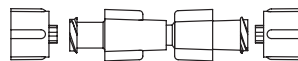

Caps

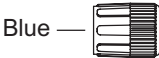
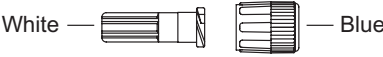
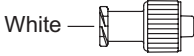
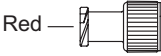
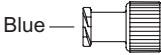
PRODUCT CODE/UPC	DESCRIPTION	FEATURES	UNITS PER CASE
MX49001 50351688506984	Female Port Cap, Red	<ul style="list-style-type: none"> • Non-DEHP Formulation • Latex-Free • Non-PVC 	100
			
MX49002 50351688506977	Female Port Cap, Blue	<ul style="list-style-type: none"> • Non-DEHP Formulation • Latex-Free • Non-PVC 	100
			
MX490C 50351688506960	Luer Lock Caps for Male and Female Ports, Sold Connected	<ul style="list-style-type: none"> • Non-DEHP Formulation • Latex-Free • Non-PVC 	100
			
MX491 50351688506953	Dual Function White Luer Lock Cap for Male and Female Ports	<ul style="list-style-type: none"> • Non-DEHP Formulation • Latex-Free • Non-PVC 	100
			
MX49101 50351688506946	Dual Function Red Luer Lock Cap for Male and Female Ports	<ul style="list-style-type: none"> • Non-DEHP Formulation • Latex-Free • Non-PVC 	100
			
MX491B 50351688506939	Dual Function Blue Luer Lock Cap for Male and Female Ports	<ul style="list-style-type: none"> • Non-DEHP Formulation • Latex-Free • Non-PVC 	100
			

1-Way Valve Medifolds

PRODUCT CODE/UPC	DESCRIPTION	FEATURES	APPROX. PRIMING VOLUME	APPROX. OVERALL LENGTH	UNITS PER CASE
MX708 50351688505611	2-Port Medifold with High Cracking Pressure Back Check Valves on Each Port, Non-Vented Green Caps on Middle Ports, Male Luer Lock	<ul style="list-style-type: none"> • Non-DEHP Formulation • Latex-Free 	1.3 mL	3" (8 cm)	25

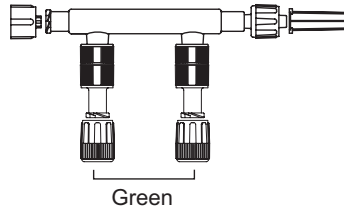

MX7083CV 50351688505604	3-Port Medifold with High Cracking Pressure Back Check Valves on Each Port, Non-Vented Green Caps on Middle Ports and In-Line Back Check Valve, Male Luer Lock	<ul style="list-style-type: none"> • Non-DEHP Formulation • Latex-Free 	2.4 mL	6" (15 cm)	25
-----------------------------------	--	--	--------	---------------	----

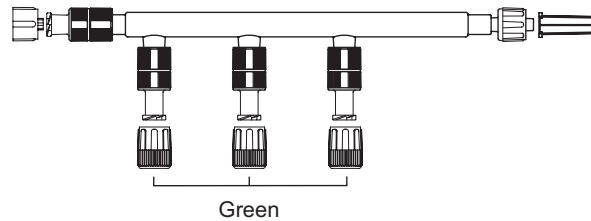

MX709 50351688505598	4-Port Medifold with High Cracking Pressure Back Check Valves on Each Port, Non-Vented Green Caps on Middle Ports, Male Luer Lock	<ul style="list-style-type: none"> • Non-DEHP Formulation • Latex-Free 	2.6 mL	6" (15 cm)	25
--------------------------------	---	--	--------	---------------	----

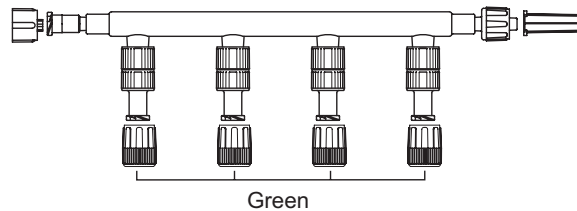

Injection Sites

PRODUCT CODE/UPC	DESCRIPTION	FEATURES	APPROX. PRIMING VOLUME	APPROX. OVERALL LENGTH	UNITS PER CASE
MX492 50351688506922	Injection Site with Male Luer Lock	<ul style="list-style-type: none"> • Non-DEHP Formulation Fluid Path • Latex-Free 	0.1 mL	1" (3 cm)	100

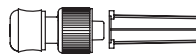

MX498 50351688506878	Injection Site with Male Luer Lock	<ul style="list-style-type: none"> • Non-DEHP Formulation Fluid Path • Latex-Free 	0.2 mL	1.5" (4 cm)	100
--------------------------------	------------------------------------	---	--------	----------------	-----



Injection Sites

PRODUCT CODE/UPC	DESCRIPTION	FEATURES	APPROX. PRIMING VOLUME	APPROX. OVERALL LENGTH	UNITS PER CASE
460000 50351688516471	Injection Site with Male Luer Lock	<ul style="list-style-type: none"> • Non-DEHP Formulation Fluid Path • Latex-Free 	0.2 mL	1.5" (4 cm)	200

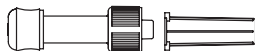

MX701 50351688505697	"W" Site with 2 Detachable Injection Sites, Female Luer Lock, Swivel Male Luer Lock	<ul style="list-style-type: none"> • Non-DEHP Formulation Fluid Path • Latex-Free 	0.8 mL	1" (3 cm)	25
--------------------------------	---	---	--------	--------------	----

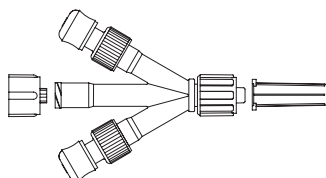

Needle-Free Access Systems

PRODUCT CODE/UPC	DESCRIPTION	FEATURES	APPROX. PRIMING VOLUME	APPROX. OVERALL LENGTH	UNITS PER CASE
SM5000 50351688500685	SmartSite® Needle-Free Valve with Male Luer Lock	<ul style="list-style-type: none"> • Non-DEHP Formulation • Latex-Free • Non-PVC 	0.1 mL	1" (3 cm)	100



SM701 50351688500494	"W" Site with 2 Detachable SmartSite® Needle-Free Valves, Female Luer Lock, Swivel Male Luer Lock	<ul style="list-style-type: none"> • Non-DEHP Formulation Fluid Path • Latex-Free 	0.9 mL	2.5" (6.3 cm)	100
--------------------------------	---	---	--------	------------------	-----

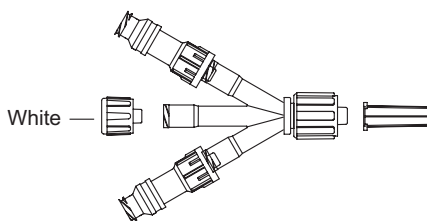

2309E N/A	SmartSite® Needle-Free Valve Bag Spike with Back Check Valve	<ul style="list-style-type: none"> • Non-DEHP Formulation • Latex-Free 			100
---------------------	--	--	--	--	-----

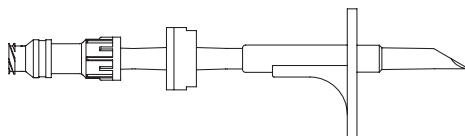

Index

REORDER NO.	PAGE	REORDER NO.	PAGE	REORDER NO.	PAGE	REORDER NO.	PAGE
2309E.....	51	MX423YSL	16	MX493.....	48	MX9311L.....	44
53035.....	21	MX434B1L	44	MX494.....	48	MX9341L.....	44
460000	51	MX448A	24	MX498.....	50	MX9342L.....	44
533640	30	MX448FMG	10	MX522L.....	18	MX20194.....	23
533640C.....	30	MX448FMG	39	MX522SL	18	MX20307R1	15
536020	31	MX448HF	34	MX580.....	25	MX43660.....	23
536035	21	MX448HF	38	MX581.....	25	MX43661.....	23
536035SC	21	MX448HFB	34	MX612H	25	MX43860.....	24
536040	31	MX448HFB	38	MX612H	35	MX49001.....	49
536040C.....	31	MX448HL	24	MX613H	26	MX49002.....	49
537220	31	MX448HL.....	34	MX613H	35	MX49101.....	49
537235C.....	21	MX448HL36	24	MX701.....	51	MX92133L.....	14
537235PS	28	MX448HL36	34	MX708.....	50	MX536020MG	11
537240PS	31	MX448HL60	25	MX709.....	50	MX536020MGIL	11
539635	21	MX448HL60	34	MX743.....	48	MX5096020MG.....	11
5360225	21	MX448HLMG.....	10	MX745.....	48	QF140	26
5360225C.....	21	MX448L.....	24	MX821L.....	5	SM701.....	51
BBF26.....	27	MX448L36	24	MX821S.....	5	SM872.....	6
BBF26DTL	29	MX448L60.....	25	MX822KMA	5	SM872M.....	4
BF13	22	MX448L60MG	10	MX822S.....	6	SM873.....	6
BF100	22	MX450FL	16	MX823S.....	6	SM924SL	20
BTF36	22	MX450SL	16	MX824.....	6	SM5000.....	51
BTF36DTL	29	MX451FL	17	MX870.....	7	SM5001.....	26
FS113	22	MX451SL	16	MX934Z3LM.....	45	SM5002.....	26
FS113	38	MX452.....	17	MX934Z4LM.....	45	SM5003.....	26
FS116	31	MX452FL	17	MX2311L.....	42	SM5004.....	27
FS116	38	MX453H2L	28	MX2341L.....	42	SM5006.....	19
FS117	31	MX453H2L	35	MX4233NS	16	SM5008.....	29
FS117	39	MX453HL	28	MX4311L.....	43	SM5009.....	6
MBF27	23	MX453HL	35	MX4312L.....	43	SM5010.....	19
MBF27DTL	30	MX453L.....	29	MX4313L.....	43	SM5011.....	19
MBF29DTL	30	MX453SL	28	MX4341L.....	43	SM5012.....	19
MBF30	23	MX454FL	17	MX4342LM.....	44	SM5014.....	27
MTF37	23	MX455FL	17	MX4343LM.....	45	SM5020.....	19
MTF37DTL.....	30	MX456CVL	17	MX4345LM.....	45	SM5020.....	39
MX048.....	15	MX456L.....	18	MX5061L.....	42	SM5021.....	20
MX252L.....	15	MX456R	17	MX5311L.....	42	SM5021.....	39
MX253L.....	15	MX457L.....	25	MX5341L.....	42	SM5024.....	20
MX254.....	15	MX458L.....	18	MX5341LN.....	42	SM7223SC	20
MX301.....	48	MX459SL	29	MX5342L.....	43	SM90976.....	7
MX412SL	15	MX490C	49	MX7083CV	50	TF55	27
MX413SL	15	MX491.....	49	MX7222SC	18	TF56	27
MX422SL	16	MX491B	49	MX7223SC	19		
MX423L.....	16	MX492.....	50	MX7322SC	5		

Smiths Medical ASD, Inc.
St. Paul, MN 55112, USA
Phone: 1-214-618-0218
Toll-Free USA: 1-800-258-5361
www.smiths-medical.com

Find your local
contact information at:
[www.smiths-medical.com/
customer-support](http://www.smiths-medical.com/customer-support)

Smiths Medical is part of the global technology business Smiths Group plc. Product[s] described may not be licensed or available for sale in all countries. Medfusion, Hi-Flo, Ultra, and the Smiths Medical, Medex and Medfusion design marks are trademarks of Smiths Medical. SmartSite is a registered trademark of Cardinal Health Systems, Inc. The symbol © indicates the trademark is registered in the U.S. Patent and Trademark Office and certain other countries. All other names and marks mentioned are the trade names, trademarks, or service marks of their respective owners. Rx only. ©2012 Smiths Medical. All rights reserved. 3/12 SM190005EN-0312

smiths medical