

Distributed By:

BOWMAN[®]



BOWMAN[®]



2013 CATALOG

www.BowmanDispensers.com

Dispensers

Personal Protective Equipment Storage & Dispensing



- Over 200 products at your fingertips
- Product and material data sheets
- Consumable Product Cross Reference Guides
- Free and downloadable isolation signage

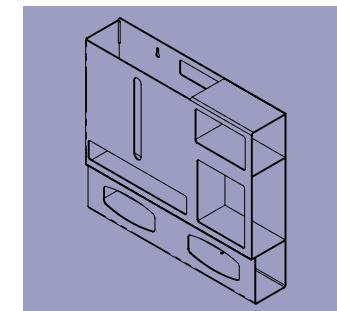
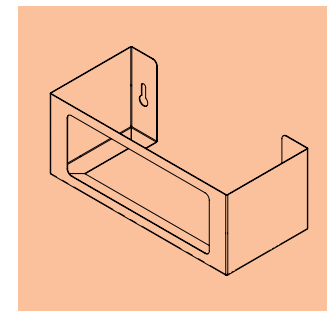
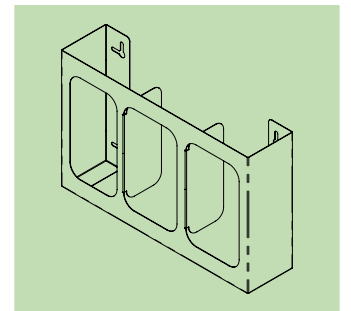
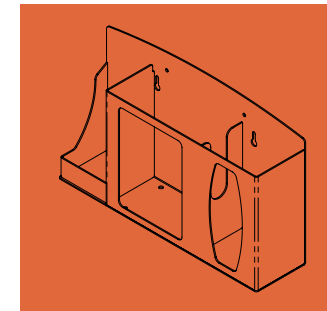
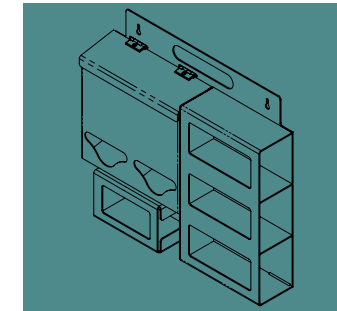
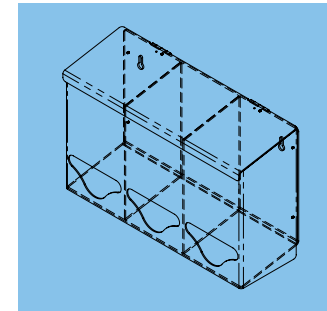

EMAIL
customerservice@bowmandispensers.com

ONLINE
www.BowmanDispensers.com

TOLL FREE
800-962-4660

FAX
360-435-5277



Health Care ■ Food Service ■ Industrial ■ Safety



Easy To Order

EMAIL
customerservice@BowmanDispensers.com

ONLINE
www.BowmanDispensers.com

TOLL-FREE
800-962-4660

FAX
360-435-5277

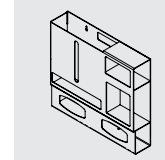

Protection Organizers and Accessories 3 - 12

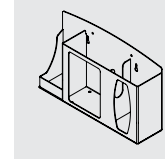

Respiratory Hygiene Stations and Floor Stands 13 - 20

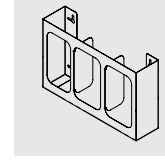

Glove Dispensers 21 - 26

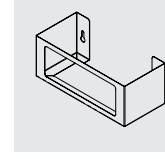

Face Mask Dispensers 27 - 32

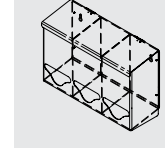

Bulk Dispensers 33 - 34

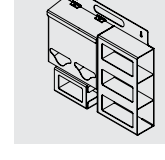

Specialty Dispensers 35 - 41



Product Index 42 - 50



LD-037
Protection Organizer
 Holds a variety of gown types, including flat-pack gowns, blue thumbs-up gowns, or launderable gowns, two boxes of gloves, one box of face masks, and one box of face shields

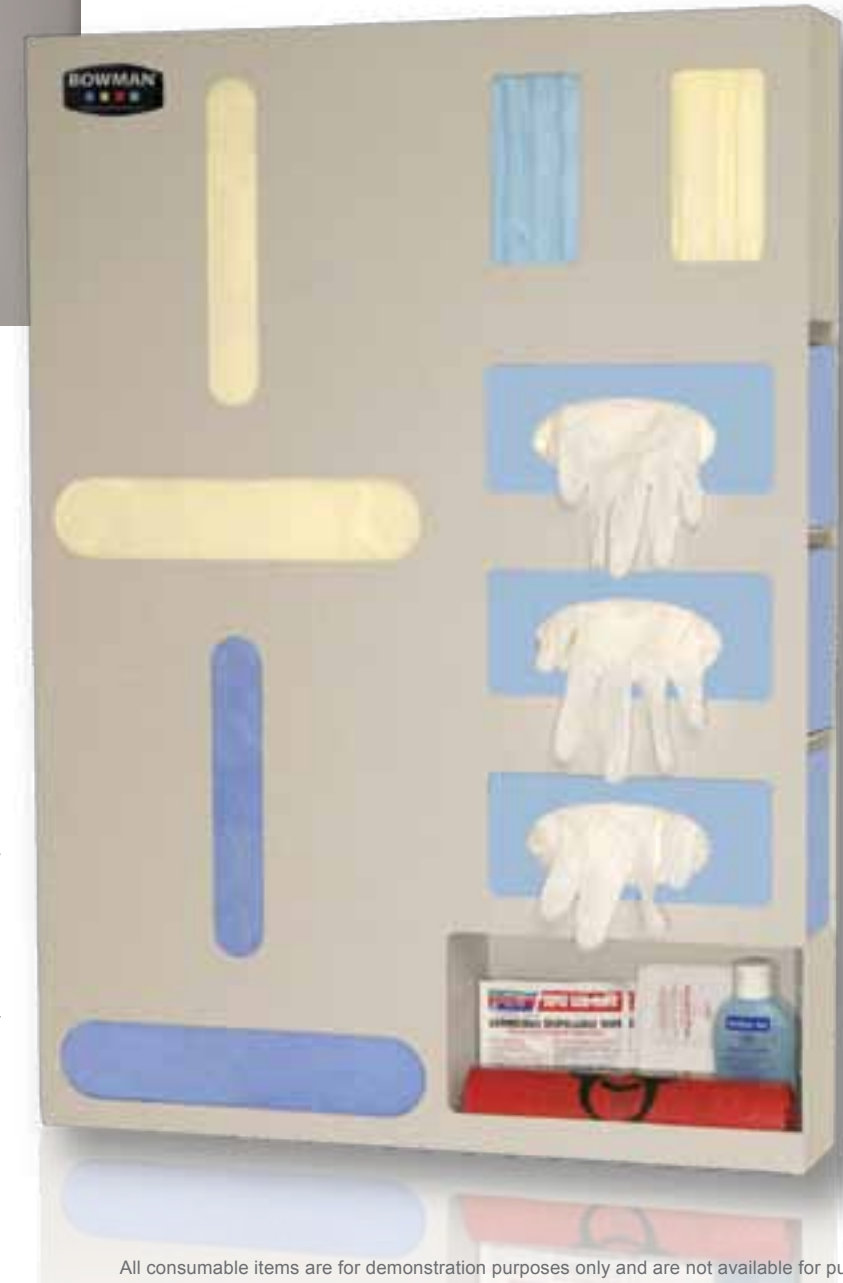

LD-062
Protection Organizer
 Holds flat-pack or launderable gowns in two compartments, three boxes of gloves, two bulk face mask sections, and an additional shelf for medical supplies

All consumable items are for demonstration purposes only and are not available for purchase through BOWMAN®.

Versatility

BOWMAN® Protection Organizers are designed to hold personal protective equipment (PPE) to protect healthcare providers. Quick access to PPE, including gloves, face masks, and gowns, makes it easier to meet compliance requirements.

- Permanent placement or portable
- Convenient and economical alternative to isolation carts

Convenience

BOWMAN® Protection Organizers can be easily customized with accessories such as glove dispensers, caddies, sign holders, and door hangers, ensuring you have the protective equipment available when and where you need it.

- Increased visibility and uniformity
- Quick and easy restocking

Top-Selling Protection Organizers

Specialty Protection Organizers

Customizable with Undermount Caddy Options

Undermount Caddies available for the LD-037 include:

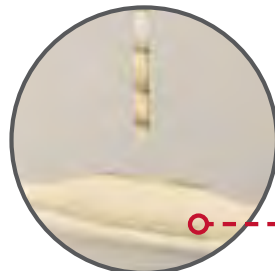

Shown with launderable gowns

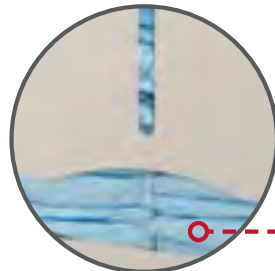

Shown with thumbs-up gowns



LD-037 Protection Organizer
Holds a variety of gown types including flat-pack gowns, blue thumbs-up gowns, or launderable gowns, two boxes of gloves, one box of face masks, and one box of face shields



GD-011 Single Glove*



GD-012 Double Glove*



GD-111 Single Glove with shelf for additional medical supplies*

*Attaches to the bottom of Protection Organizer LD-037 (hardware included)

Gloveless



LD-040 Gloveless - Compact
Holds a variety of gowns, one box of face masks, and one box of face shields



PS003-0212 Gloveless - Left Loading Gown Opening
Holds gowns in bulk, one box of face masks, and one box of face shields



PS007-0212 Double Gown with Built-In Caddy
Holds flat-pack gowns and thumbs-up gowns in box or bulk quantity, one box of face shields, and contains two built-in caddies to hold a variety of items, such as wet wipe canisters and hand gel dispensers

Triple Glove



LD-007 Basic Triple Glove
Holds flat-pack or launderable gowns, three boxes of gloves, and one box of face masks



LD-062 4" Deep - Double Gown
Holds flat-pack or launderable gowns in two compartments, three boxes of gloves, two bulk face mask sections, and an additional shelf for medical supplies



LD-070 Triple Glove with Face Shield
Holds flat-pack or launderable gowns, three boxes of gloves, one box of face masks, and one box of face shields



LD-064 4" Deep
Holds flat-pack or launderable gowns, three boxes of gloves, face masks in bulk, and contains a built-in storage caddy



LD-067 Launderable Gowns
Holds launderable gowns, two boxes of gloves, and one box of face masks



RD-060 Protection Organizer, Custom-Fold Gown
Holds custom-fold gowns, two boxes of face masks, and two boxes of gloves

Additional Configurations

All consumable items are for demonstration purposes only and are not available for purchase through BOWMAN®.

Customize Your Protection Organizer

PS012-0512
Protection Organizer – All Aluminum

Shown with Protection Organizer accessories MP-047 (sign holder) and MP-085 (caddy)

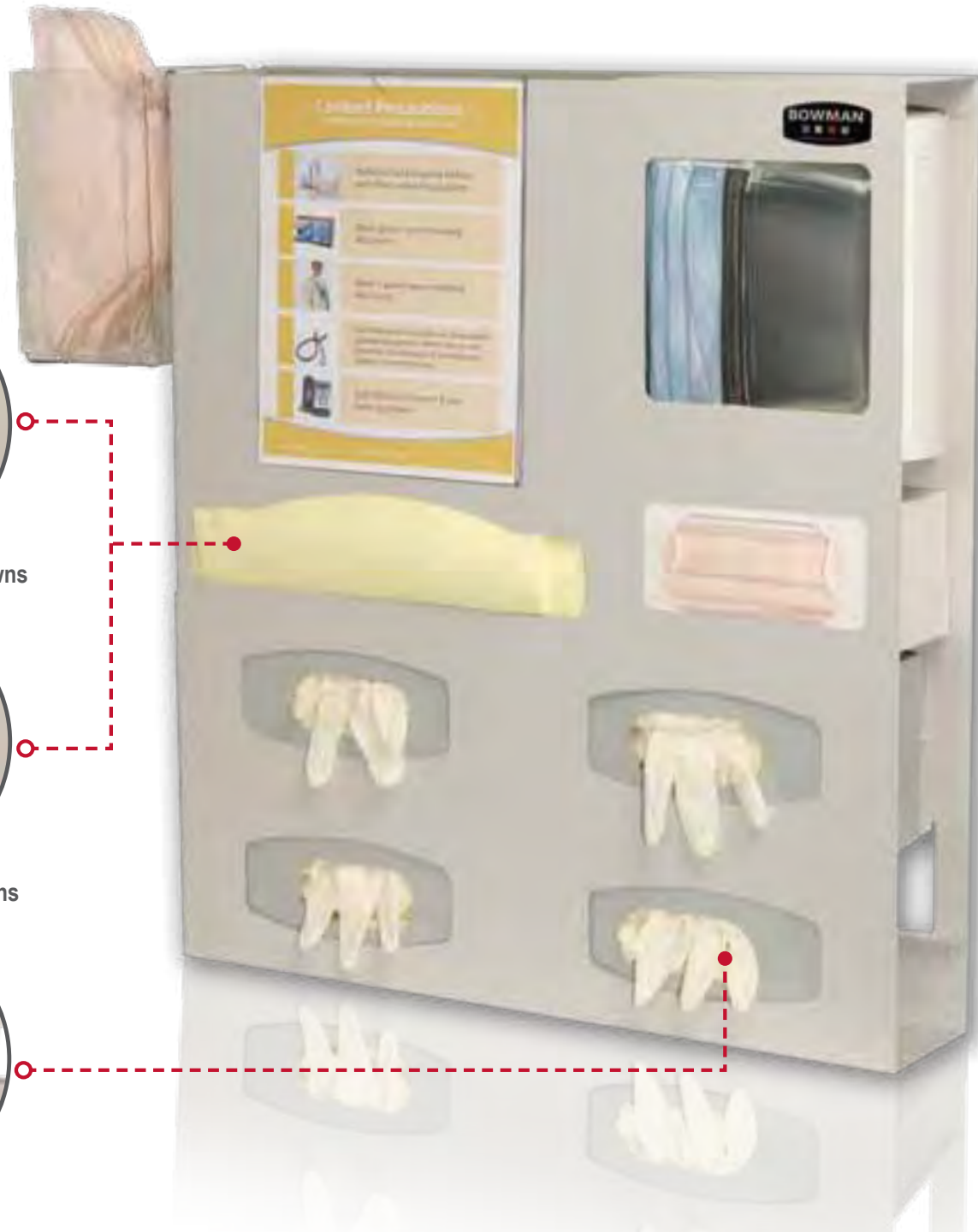

Shown with launderable gowns

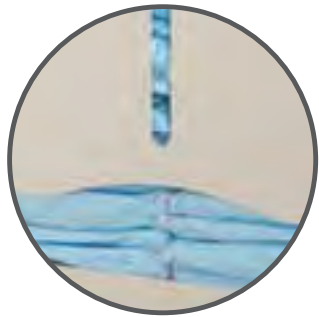

Shown with thumbs-up gowns



Shown with roll of bags

Benefits of Customization

Customizing your BOWMAN® Protection Organizer gives you added accessibility to the personal protective equipment (PPE) you need. Ready availability to PPE assists your efforts in preventing infection and remaining compliant with infection prevention standards.

Customize Your Protection Organizer

Clip-On Caddies

- Clip-on design in various sizes holds items such as N-95 masks, safety glasses, bags, wet wipe canisters, gloves, etc.
- May be used with protection organizers that are 4" deep or greater
- Made of clear PETG plastic

MP-042



MP-085



MP-015



Quick Reference Guide and Clip-on Sign Holder

Early and Effective Isolation

Quick Reference Card



RG-006
Horizontal



Provides a quick reference to the 2007 HICPAC/CDC guidelines for precautions required for frequently isolated organisms. Made of PVC plastic. Also available in a vertical style - RG-008



Attach to name badge



Place isolation sign holder on Protection Organizer



Place signage in sign holder



MP-047

Download free Isolation Precaution signage by visiting our website at www.BowmanDispensers.com



Mounting Options – Permanent

Standardize PPE location

Increase compliance by mounting BOWMAN® protection organizers to the wall outside each patient room.

Utilize convenient keyholes located on the back of our protection organizers or mount our metal wall hanger to the wall and hang the organizers on them.

Utilizing Keyholes



Keyholes enable permanent mounting to a wall (LD-037 shown)

Utilizing a Wall Hanger



MB-510 Wall Hanger
Holds protection organizers on a wall
Made of quartz powder-coated steel

Mounting Options – Portable

Mounting On A Glass Door



LD-037 shown mounted to a glass door

Mount this BOWMAN® door hanger on glass doors in areas where wall space is limited.



MB-500 Door Hanger for Glass Doors
Holds protection organizers on glass utilizing double-sided, semi-permanent tape
Made of quartz powder-coated steel

Fire Door



Easily adjustable

MB-450 Door Hanger for Metal Bracketed Fire Doors
Holds protection organizers at adjustable heights to accommodate door hardware on fire doors
Made of quartz powder-coated steel



Fire door hanger shown with protection organizer LD-037

Traditional Door





Our most popular standard door hanger, the MB-600, holds BOWMAN® protection organizers on standard-sized doors. The MB-601 is designed for extra tall doors. Made of quartz powder-coated steel.







MB-600 12" Door Hanger for Standard-sized Doors
Hooks over the top of a door with a thickness no greater than 2 7/16".
Available for extra tall doors MB-601 - 19" Door Hanger.



Door hanger MB-600 shown with protection organizer LD-037

Protection Organizer				
	LD-007	LD-037	LD-062	LD-064
Material	Quartz ABS Plastic	Quartz ABS Plastic	Quartz ABS Plastic	Quartz ABS Plastic
Dimensions	16 5/8"W x 25 1/4"H x 4 1/2"D	22 3/4"W x 20 1/2"H x 4 3/4"D	22 1/4"W x 30 3/4"H x 4"D	16 3/4"W x 25 5/8"H x 4"D
Permanently Mounted / Portable	•	•	•	•
4" (or less) Deep Unit			•	•
Launderable Gowns		•	•	•
Disposable Flat-Pack Gowns	•	•	•	•
Disposable Blue Thumbs-Up Gowns		•		
Gowns, Single	•	•		•
Gowns, Double			•	
Isolation Sign Holder		•	•	•
Gloves, Double		•		
Gloves, Triple	•	Add GD-011 or GD-111	•	•
Gloves, Quad		Add GD-012		
Face Masks, Ear Loop - Single	•	•		•
Face Masks, Ear Loop - Double			•	
Face Shield Masks		•		
Cone-Shaped Face Masks				
Storage Add-On	MP-015, MP-042, MP-085	MP-015, MP-042, MP-085		
Storage Built-In		Add GD-111	•	•

				
LD-067	LD-070	PS007-0212	PS012-0512	RD-060
Material	Quartz ABS Plastic	Quartz ABS Plastic	Quartz Powder-Coated Aluminum	Quartz ABS Plastic
Dimensions	19 11/16"W x 28 5/8"H x 4 3/4"D	20 1/16"W x 25 1/4"H x 4 3/4"D	20"W x 20 15/16"H x 4 15/16"D	22 3/4"W x 25 5/8"H x 4 9/16"D
Permanently Mounted / Portable	•	•	•	•
4" (or less) Deep Unit				•
Launderable Gowns	•		•	
Disposable Flat-Pack Gowns		•	•	
Disposable Blue Thumbs-Up Gowns		•	•	
Gowns, Single		•	•	
Gowns, Double	•			Custom-fold
Isolation Sign Holder	•		•	
Gloves, Double	•			•
Gloves, Triple		•		
Gloves, Quad			•	
Face Masks, Ear Loop - Single	•	•	•	
Face Masks, Ear Loop - Double				•
Face Shield Masks		•	•	
Cone-Shaped Face Masks		•		
Storage Add-On	MP-015, MP-042, MP-085	MP-015, MP-042, MP-085	MP-015, MP-042, MP-085	MP-015, MP-042, MP-085
Storage Built-In		•		



Comply with the CDC guidelines and take precautions to prevent the transmission of respiratory infections.

Public Area Protection

CDC Recommendations*
To prevent the transmission of respiratory infections

- **Visual Alerts**
Post visual alerts at the entrances to healthcare facilities, including emergency departments, physician offices, clinics, etc.
- **Cleaning Hands**
Use of antiseptic handwash if a sink for hand washing is not available.
- **Wearing Face Masks**
Wear a mask if coughing. Masks available for visitor use.
- **Using Tissues**
Cover the nose and mouth with a tissue when coughing or sneezing and properly dispose of them after use.

RS001-0212
Respiratory Hygiene Station
Shown with optional sign holder MP-070 (sold separately)



Download free bilingual Cover Your Cough signage by visiting our website at www.BowmanDispensers.com



MP-070
Sign Holder - Vertical

*This information is based on the Guideline for Isolation Precautions: Preventing Transmission of Infectious Agents in Healthcare Settings. Recommendations of the Healthcare Infection Control Practices Advisory Committee (HICPAC), CDC.

Protecting Ports of Entry

Versatility

Most units may be mounted to a floor stand, hung on a wall, or set on a counter.

Cost Effectiveness

Infectious outbreak investigations and staff absenteeism are very costly. BOWMAN® Respiratory Hygiene Stations provide the items needed to support your efforts in preventing the transmission of infections.



Lobby or waiting room - mounted on a floor stand



Medical office or clinic - set on a countertop

Convenience

Place where infection prevention supplies are needed most – at ports of entry.

Durability

BOWMAN® Respiratory Hygiene Stations are made of quartz ABS plastic (some locking units have clear PETG plastic lids).



At ports of entry or near an elevator - hanging on a wall

Accessibility

Standardizing the location of infection prevention supplies.

MP-070
Sign Holder - Vertical
Made of clear PETG plastic



RS001-0212
Accommodates either one bottle of hand sanitizing gel or one container of hand sanitizing wipes
Shown with optional sign holder MP-075 (sold separately)

RS001-0212
Respiratory Hygiene Station
Made of quartz ABS plastic

KS010-0412
Floor Stand
Made of quartz powder-coated steel

Protecting Ports of Entry

Bottled Hand Gel

MP-070



Respiratory Hygiene Station

Holds two boxes of face masks, facial tissue, and either a bottle of hand sanitizing gel or a hand sanitizing wipes container

Shown with optional vertical sign holder MP-070 (sold separately)

Keyholes for wall mounting, can sit on a counter, or mount to a floor stand

Locking unit (FD-062) also available

RS001-0212

Hand Sanitizer Pump or Foam Dispenser

Respiratory Hygiene Station

Holds two boxes of face masks, 1-2 boxes of facial tissues, and one hand sanitizer pump or foam dispenser (not included)

Shown with optional vertical sign holder MP-070 (sold separately)

Keyholes for wall mounting or may be mounted to a floor stand

Non-locking unit (FD-111) also available



FD-112 shown with sanitizing foam dispenser

MP-070



FD-112

Station has a hinged locking lid

Mask and Facial Tissue Only

MP-070



Respiratory Hygiene Station - Locking

Holds two boxes of face masks and facial tissue

Shown with optional vertical sign holder MP-070 (sold separately)

Keyholes for wall mounting

Perfect for scenarios where you have hand gel dispensers already in place.

RS002-0212

Infection Prevention Organizers



ED-097

Infection Prevention Organizer

For use in hospital, office, business, and school settings to help prevent the spread of infection.

Holds 1-2 boxes of facial tissue, one hand sanitizer bottle, and accommodates a variety of wet wipe dispensers

11" x 8 1/2" horizontal sign holder MP-075 included with unit

Keyholes for wall mounting, can sit on a counter, or mount to a floor stand

FD-068

Infection Prevention Organizer

Designed specifically for clinics, physician offices, and ambulatory surgery centers to help prevent the spread of infection.

Holds two boxes of gloves, one box of face masks, and one hand sanitizer bottle

Keyholes for wall mounting, can sit on a counter, or mount to a floor stand

Protecting Ports of Entry



KS102-0029

Hand Sanitizer Floor Stand
Shown with hand gel dispenser (not included)

- Accommodates most major manufacturers' hand sanitizer, hand lotion, and foam dispensers
- No tools required to assemble
- Self-righting base, up to 40° past center (without dispenser)
- Easy-to-clean drip tray made of quartz ABS plastic
- Back plate, column, and base made of bay gray powder-coated steel

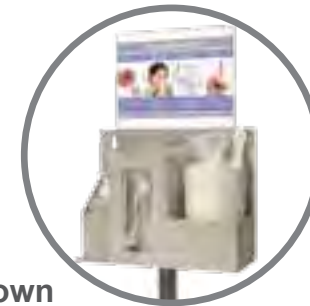

Shown with ED-097



Shown with FD-068



Mounting plate shown

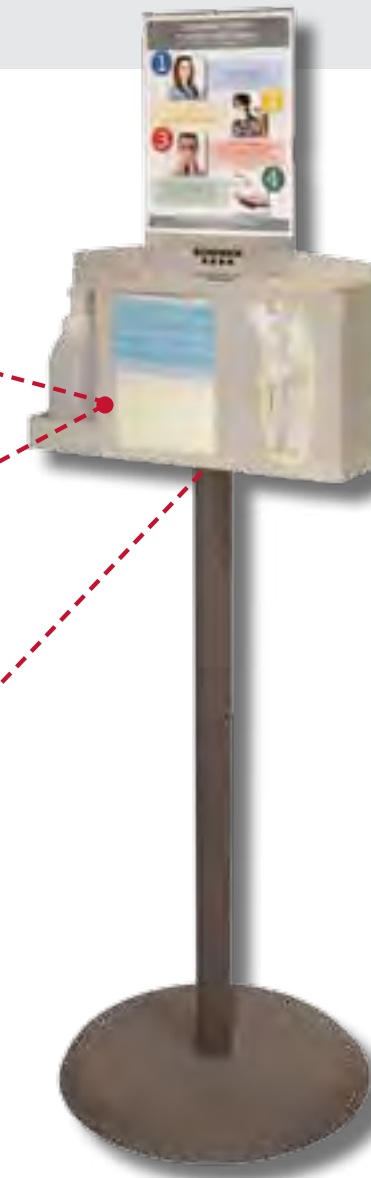

KS201-0029
Floor Stand

Shown with RS001-0212 and optional sign holder MP-070

Floor stand with mounting plate supports a variety of Respiratory Hygiene and Infection Prevention Stations (each sold separately)

- No tools required to assemble
- Self-righting base, up to 40° past center (without dispenser)
- Bay gray powder-coated steel mounting plate, column, and base

Hand Gel Bottle Holders



MD-015
Hand Gel Bottle Holder
Holds one bottle of hand gel
Screw holes for wall mounting
Made of white ABS plastic



WP-110
Bottle Holder
Holds one liquid hand gel bottle, approximately 500 ml, (or one elephant ear wash bottle)
Keyholes for wall mounting
Made of clear PETG plastic



GL100-0212
Single Glove Box
Dispenser



Benefits of BOWMAN® Glove Box Dispensers

- Most glove box dispensers mount both vertically and horizontally
- Available in stainless steel, powder-coated steel, PETG plastic, ABS plastic, Sintra plastic, polycarbonate plastic, and coated wire
- Universal fit for most standard glove boxes
- Most materials available in single, double, triple, and quad configurations
- Minimal to full box visibility
- Private labeling available for most units

Mounting Options

Two or three-way keyholes enable most BOWMAN® glove box dispensers to be mounted either vertically or horizontally.



GS-123
Mounted horizontally



GS-123
Mounted vertically

Alternate Uses

Facial tissues



GB-001

Personal wipes



GS-004



GL300-1214
Triple Glove Box
Dispenser
with dividers

Material	Single	Double	Triple	Quad
Stainless Steel				
	GS-004	GS-005	GS-006	GS-060
Powder-Coated Steel				
	GB-001	GB-002	GB-003	GB-059
Quartz ABS Plastic				
	GL100-0212	GD-042	GL300-0212	GL042-0212
Clear PETG* or Polycarbonate** Plastic				
	GL100-1214**	GP-014*	GL300-1214**	GP-061*
White Coated Wire				
	GW-029	GW-040	GW-050	GW-065

Divided Glove Box Dispensers

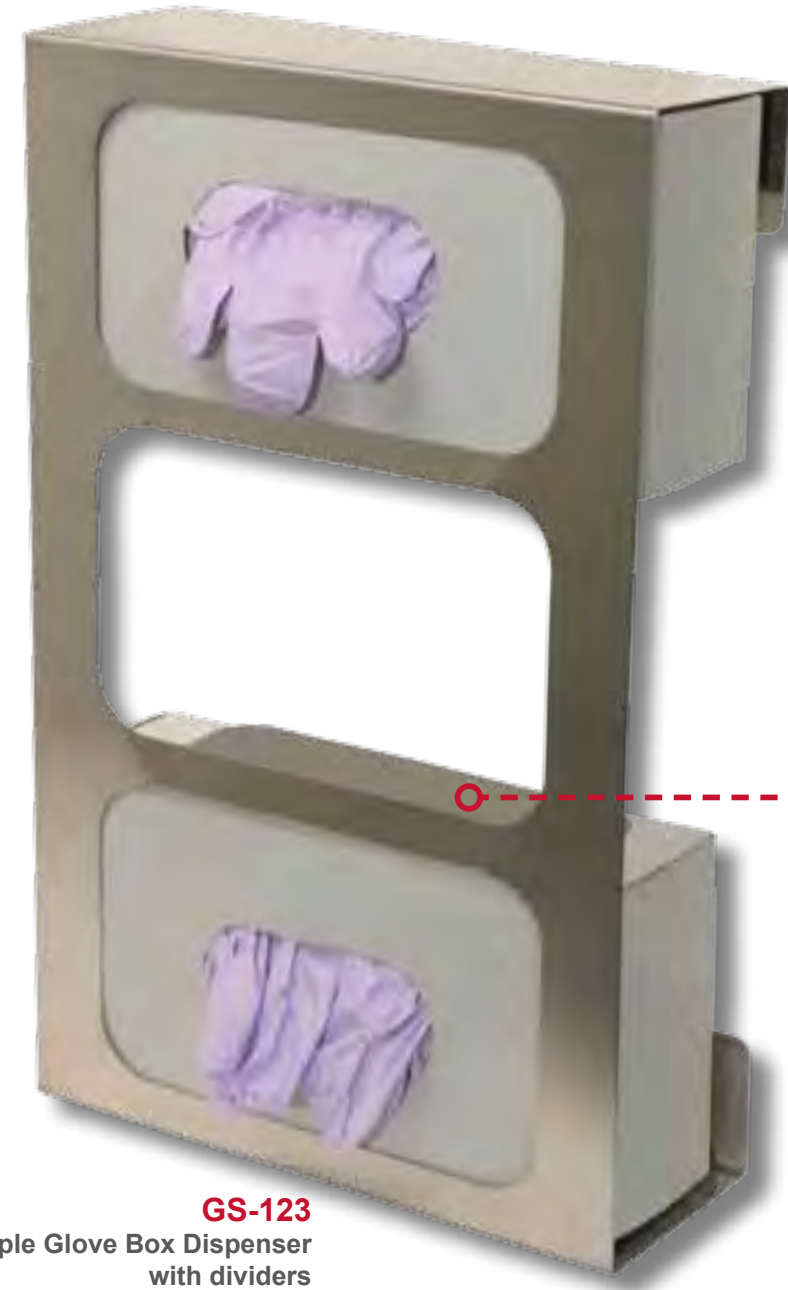

- Dividers keep multiple boxes in place during restocking
- Units mount vertically and horizontally
- Universal fit for most standard healthcare glove boxes
- Available in stainless steel, polycarbonate, PETG, and ABS plastic

GS-123
Triple Glove Box Dispenser with dividers

Material	Double	Triple	Quad
ABS Plastic	GD-042	GL300-0212	GL042-0212
PETG* & Polycarbonate** Plastic	GP-042*	GL300-1214**	N/A
Stainless Steel	GS-122	GS-123	GS-124

All consumable items are for demonstration purposes only and are not available for purchase through BOWMAN®.

Horizontal Stacking Glove Box Dispensers

Contain keyholes for wall mounting.
Made of clear PETG plastic.



GP-310



GP-320



GP-330



GP-340

Space Saver Glove Box Dispensers

Vertical Stainless Steel



GS-108

GS-109

Vertical Powder-Coated Steel



GB-067

GB-068

Vertical Clear PETG Plastic



GP-106

GP-107

Space Saver Glove Box Dispensers are loaded from the top only and therefore require that all glove boxes be removed to replace the bottom box.

Specialty Glove Box Dispensers

Chemotherapy Glove Box Dispenser



GP-120

Holds one box of chemotherapy gloves
Made of clear PETG plastic

Sterile Glove Box Dispenser



GL041-0212

Designed to hold four boxes of Cardinal Flexam sterile exam gloves
Made of quartz ABS plastic

Glove Box Dispenser - Quad with Shelf



GL042-0212

Shelf on top for additional medical supplies
Made of quartz ABS plastic

Large Capacity Glove Box Dispenser



GL031-0413

Holds three boxes up to 4 1/2" deep
Made of white powder-coated steel
Single large capacity options - GB-074, GP-020, and GS-073

Food Service Poly Glove Box Dispenser



GS-026

Made of stainless steel
Also available in white powder-coated steel - GB-027
and clear PETG plastic - GP-025

Bulk Dispenser Shown with Gloves



BP-021

Bulk Dispenser
Made of clear PETG plastic



Face Mask Dispenser Types

Earloops



FB-037
White powder-coated steel

FP-021
Clear PETG plastic

Exact Fit face mask dispensers for most standard size boxes

Face Shields



FB-090
White powder-coated steel

FP-120
Clear PETG plastic

Exact Fit face shield dispensers for most standard size boxes

Ties



FB-021
White powder-coated steel

Exact Fit face mask dispensers for most standard size boxes

Bulks



FD-005
One box capacity

FD-010
Three box capacity

FP-017
Cone Masks

Holds face masks in bulk quantities
Made of clear PETG plastic

Combo Units



MB-085
Holds one box of face masks and one box of gloves
Bronze powder-coated steel

RS001-0212
Holds two boxes of face masks, facial tissue, and either a bottle of hand sanitizing gel or a hand sanitizing wipes container
Can be mounted on a wall or floor stand or can sit on a counter

**FM001-0213
Surgical Face Mask Dispenser**

Holds up to six boxes of face masks with dividers
Sits on countertop
Keyholes for wall mounting
White ABS plastic

**FM002-0213
Face Mask Combo Dispenser**

Holds one box of earloop or tie-style face masks, one box of face shield masks, and two boxes of flat-fold N-95 masks
White ABS plastic















All consumable items are for demonstration purposes only and are not available for purchase through BOWMAN®.

Benefits of BOWMAN® Face Mask Dispensers

- BOWMAN® face mask dispensers accommodate most major mask manufacturers' products
- Rugged design offers high impact and chemical resistance
- Made from either transparent PETG plastic or solid powder-coated steel materials
- Universal wall mounting provides easy installation
- Face Mask Cross Reference Tools available on page 30 and 32 of this catalog or you may access them by visiting our website at www.BowmanDispensers.com

Clear PETG Plastic

Part Number	Image	Units	W (L)	H	D	Weight	
FP-007		IN	6 9/16	8 1/2	5 5/16	LB	0.75
		CM	16.7	21.7	13.5	KG	0.3
FP-009		IN	5 1/2	7 3/4	5 1/2	LB	0.60
		CM	14.0	19.8	14.0	KG	0.3
FP-010		IN	9 11/16	7 3/16	3 11/16	LB	0.65
		CM	24.6	18.2	9.4	KG	0.3
FP-015		IN	10 9/16	4 1/8	4 15/16	LB	0.40
		CM	26.9	10.5	12.6	KG	0.2
FP-021*		IN	7 15/16	4 1/4	5 3/16	LB	0.45
		CM	20.2	10.7	13.2	KG	0.2
FP-022		IN	8 1/8	7 3/4	4 15/16	LB	0.90
		CM	20.6	19.6	12.5	KG	0.4
FP-028		IN	7 11/16	5 5/8	5 3/16	LB	0.55
		CM	19.6	14.2	13.2	KG	0.2
FP-038*		IN	7 11/16	4 5/16	4 1/4	LB	0.40
		CM	19.6	11.0	10.8	KG	0.2
FP-084		IN	5 3/16	6 1/8	5 5/16	LB	0.50
		CM	13.1	15.5	13.5	KG	0.2
FP-119		IN	4 11/16	6 1/2	4 11/16	LB	0.55
		CM	11.9	16.5	11.9	KG	0.2
FP-120		IN	9 3/16	7 1/2	4 3/16	LB	0.70
		CM	23.4	19.1	10.7	KG	0.3
FP-121*		IN	7 11/16	4 3/8	4 1/8	LB	0.45
		CM	19.6	11.0	10.5	KG	0.2
FP-122		IN	8 1/16	7 5/8	5 9/16	LB	0.75
		CM	20.5	19.3	14.2	KG	0.3

*Dispenses from top or front

Face Mask Cross Reference Guide

Part Number	3M	Cardinal	Gerson	Kimberly Clark	McKesson	MediChoice	Medline	Moldex	Precept	Sperian	Tidi
FP-007	8511										
FP-009	1860, 1860S		1730, 2735				NON24506	2200N95, 1200, 2300N95, 2730, 2730N100, 1512N95	65-3395S		
FP-010	1870, 9210										
FP-015				46767							
FP-021							NON27110, NON27120, NON27374, NON27385, NON27377, NON27412EL		15100, 15101, 15130, 15155, 15160, 15200, 15211, 15212, 15260, 15300, 15320, 15500, 653320, 653322		
FP-022		AT54535, AT71035				0205PG42073, 0205PG42121, 0205PG42333, 0205PG43092, 0205PG44073	NON27361A, NON27382, NON27408, NON27412				
FP-028	1835					91-1200, 91-1400, 91-1000					
FP-038	1840	AT7004, AT7511		47127, 48100		91-2002	NON27122, NON27375, NON27378				9010, 9020, 9030, 9040
FP-084	1800+NL	N95-ML, N95-S					0205PG40220		65-3333		
FP-119		AT7509					NON27381				
FP-120	1818	AT54635, AT71039, AT74631, AT74635, AT7511-WE		28800, 28804, 28809, 28821, 47147, 47500, 48247, 62114		91-2600, 91-1600	0205PG41573, 0205PG41592, 0205PG42592, 0205PG45033, 0205PG45073	NON27600	15310, 15330	14110452, One Fit W1400	
FP-121	1816	AT70021, AT7004, AT71021, AT74531, AT771141, AT771211, AT7511		25867, 25868, 25869, 28808, 28810, 47080, 47095, 47107, 47117, 47127, 48100, 48201, 49310		91-2002	0205PG41001, 0205PG41010, 0205PG41092, 0205PG41201, 0205PG41331	NON27122, NON27375, NON27378			
FP-122	8514			48220, 49215, 49235							

All consumable items are for demonstration purposes only and are not available for purchase through BOWMAN®.

White Powder-Coated Steel

Part Number	Image	Units	W (L)	H	D	Weight	
FB-001		IN	5 11/16	6 7/16	5 1/16	LB	1.00
		CM	14.5	16.3	12.9	KG	0.5
FB-002		IN	6 7/16	8 1/2	5 3/16	LB	1.35
		CM	16.4	21.7	13.1	KG	0.6
FB-003		IN	8 1/16	9	5 3/16	LB	1.65
		CM	20.5	22.9	13.2	KG	0.7
FB-004		IN	5 5/16	7 3/4	5 5/16	LB	1.22
		CM	13.5	19.8	13.5	KG	0.6
FB-007		IN	5 7/8	10 11/16	5 1/16	LB	1.65
		CM	15.0	27.1	12.9	KG	0.7
FB-010		IN	10 7/16	4 1/8	4 13/16	LB	0.70
		CM	26.5	10.5	12.2	KG	0.3
FB-021*		IN	7 7/16	4 3/4	4 13/16	LB	0.85
		CM	18.9	12.1	12.2	KG	0.4
FB-037		IN	7 9/16	4 1/4	4 1/8	LB	0.65
		CM	19.2	10.8	10.5	KG	0.3
FB-063*		IN	7 13/16	7 1/2	5 1/4	LB	1.35
		CM	19.8	19.1	13.3	KG	0.6
FB-064*		IN	7 9/16	4 1/4	4 1/8	LB	0.75
		CM	19.2	10.8	10.5	KG	0.3
FB-090		IN	9 1/16	7 1/2	4 1/16	LB	1.15
		CM	23.0	19.1	10.3	KG	0.5
FB-091		IN	7 7/8	7 11/16	5	LB	1.20
		CM	20.1	19.6	12.7	KG	0.5

*Dispenses from top or front

Face Mask Cross Reference Guide

Part Number	3M	Cardinal	Gerson	Kimberly Clark	McKesson	MediChoice	Medline	Moldex	Precept	Sperian	Tidi
FB-001	1860S, 8210							1200			
FB-002	8511										
FB-003	1838R, 8514										
FB-004								2730N100, 1512N95, 2200N95, 2300N95, 2730			
FB-007										14110388 (N1105)	
FB-010				46767							
FB-021	1835				91-2002		NON27374, NON27376, NON27385		15200, 15211, 15212, 15260, 15320, 653320, 653322		
FB-037	1840	AT7004, AT7511		25867, 25868, 25869, 28808, 28810, 47080, 47095, 47107, 47117, 47127, 48100, 48201, 49310	91-2002		NON27122, NON27375, NON27378				9010, 9020, 9030, 9040
FB-063							NON27412				
FB-064	1816, 1840	AT70021, AT7004, AT71021, AT7511, AT771211, AT74531, AT771141		25867, 25868, 25869, 28808, 28810, 47080, 47095, 47107, 47117, 47127, 48100, 48201, 49310		0205PG41001, 0205PG41010, 0205PG41092, 0205PG41201, 0205PG41331	NON27122, NON27375, NON27378				
FB-090	1818	AT54635, AT71039, AT74631, AT74635, AT7511-WE		28800, 28804, 28809, 28821, 47147, 47500, 48247, 62114	91-2600, 91-1600	0205PG41573, 0205PG41592, 0205PG42592, 0205PG45033, 0205PG45073	NON27600		15310, 15330	14110452, One Fit W1400	
FB-091		AT51035, AT54535, AT71235, AT72835, AT73035, AT7505-P, AT752005, AT771145, AT74535		48220, 49215, 49235			NON27361A, NON27382, NON27408				

All consumable items are for demonstration purposes only and are not available for purchase through BOWMAN®.



Bulk Dispenser Types

Universal Bulk Bins



BP-021 Single Bin **BP-022** Double Bin **BP-023** Triple Bin **BP-011** Tall Single Bin **BP-012** Tall Double Bin **BP-090** Tall Triple Bin

Holds PPE, such as bouffant caps, shoe covers, beard restraints, gloves, etc. in bulk quantity. Made of clear PETG plastic.

Apron and Gown Dispensers



RP-011
Gown Dispenser with a Hinged Lid
Holds a variety of gowns in bulk
Hinged lid with opening at bottom of unit
Clear PETG plastic face with white ABS plastic back

GN001-0212
Gown Dispenser with a Hinged Lid
Holds a variety of gowns in bulk quantity
Hinged lid with opening at bottom of unit
Quartz ABS plastic

RP-030
Thumbs-Up Gown Dispenser
Holds disposable isolation gowns in bulk or in the box
Clear PETG plastic

RD-009
Gown Dispenser, Custom-Fold Gown
Holds custom-fold gowns in bulk quantity
Quartz ABS plastic

BK001-0300
Bulk Dispenser-Tall Single Bin with a Hinged Lid

Holds a variety of PPE, including gloves, bouffant caps, shoe covers, etc. Made of stainless steel



GN100-0212
Universal Thumbs-Up Gown Dispenser

Holds one box of disposable isolation gowns with three built-in flexible springs that accommodate a variety of box sizes
Made of quartz ABS plastic





Surgical Dispensers



LP-004

Protection Organizer
Holds bulk quantity protective apparel in two separate bins with lid, three boxes of gloves, and one box of face masks
Keyholes for wall mounting and door hanger cutout
Quartz ABS plastic and clear PETG plastic

Eye Shield Dispenser
Exact fit for the Flip-Ease eye shield
Clear PETG plastic



FP-027

Bouffant Cap and Shoe Cover Dispensers



BB-001
Bouffant Cap or Shoe Cover Dispenser
Keyholes for wall mounting
White powder-coated steel



BP-007
Bouffant Cap or Shoe Cover Dispenser
Keyholes for wall mounting
Clear PETG plastic



SP-003
Shoe Cover Dispenser
Keyholes for wall mounting
Clear PETG plastic



SP-573
Shoe Cover Dispenser
Keyholes for wall mounting
Clear PETG plastic

Surgical Apparel Organizer
Two covered bulk areas on top hold a variety of PPE such as bouffant caps, shoe covers, etc.
Compartment on bottom holds jumpsuits, coveralls, or disposable gowns in bulk quantity
Keyholes for wall mounting
Clear PETG plastic and white ABS plastic



SD-010

Emergency Ambu-bag Dispenser

Holds Infant, Child, and Adult Ambu-bags in one location

For use in:

- Pediatrics
- Emergency Clinics
- Anesthesia
- Pediatric ICU
- Emergency Departments
- Operating Room

RC001-0111
Bag Valve Mask* Dispenser

Holds up to three different sizes of bag valve masks in divided sections with one hinged lid covering all sections
Includes a break-away lock area
Keyholes for wall mounting
Clear PETG plastic and quartz powder-coated aluminum

*Abbreviated BVM and also referred to as Ambu bags.





CP-075 Eyewear Cabinet - Locking

Holds up to ten pairs of safety glasses
White ABS plastic with clear PETG plastic locking door
Large capacity cabinet available that accommodates 12+ safety glasses - CP-076



Laboratory Bio-Shields

LB001-0111

Bio-Shield - Large
For use in laboratories to protect from splashes from blood and body fluids
Clear PETG plastic
Also available in small size - LB002-0111



Task Wipe and Towel Dispensers



CL002-0111

Task Wipe Dispenser - Small
Holds a small box of task wipes
Clear PETG plastic



TB-002

Towel Dispenser
Holds packages of quarter-fold towels
White powder-coated steel

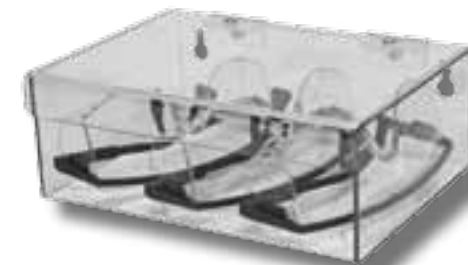

CP-072

Eyewear Dispenser - Hinged Lid Top

Holds up to six pairs of safety glasses
Clear PETG plastic

Biohazard Bag Holders



MW-001

One-gallon capacity

MW-003

Three-gallon capacity

MW-005

Five-gallon capacity

Biohazard Bag Holders

Holds a one-, three-, or five-gallon biohazard bag
Screw holes for wall mounting
White coated wire



CL003-0111

Task Wipe Dispenser - Large
Holds a large box of task wipes
Clear PETG plastic



TB-003

Towel Dispenser - Large capacity
Holds packages of quarter-fold towels
White powder-coated steel



EP-105

Ear Plug Dispenser
Holds ear plugs in bulk quantity
Clear PETG plastic



SS001-0212

Eye and Ear Safety Station

Holds two small boxes of eye-cleaning wipes, one bottle of lens cleaning solution, and ear plugs in bulk quantity
Keyholes for wall mounting, can sit on counter, or mount to a floor stand
Quartz ABS plastic



Bedpan and Urinal Dispenser



BG001-0212

Bag Dispenser - Single

Holds a single roll of bags (up to 9" long)
Quartz ABS plastic
Also available in clear PETG plastic - BG001-0111



BG002-0212

Bag Dispenser - Double

Holds two rolls of bags (up to 9" long)
Quartz ABS plastic
Also available in clear PETG plastic - BG002-0111



PS004-0212

Triple Glove and Single Roll Bag Dispenser

Holds three boxes of gloves and one roll of bags (garbage, biohazard, laundry, etc.)
Quartz ABS plastic
Also available in clear PETG plastic - PS004-0111



Shown with fracture pan



Shown with white hat



Shown with oversized bed pan

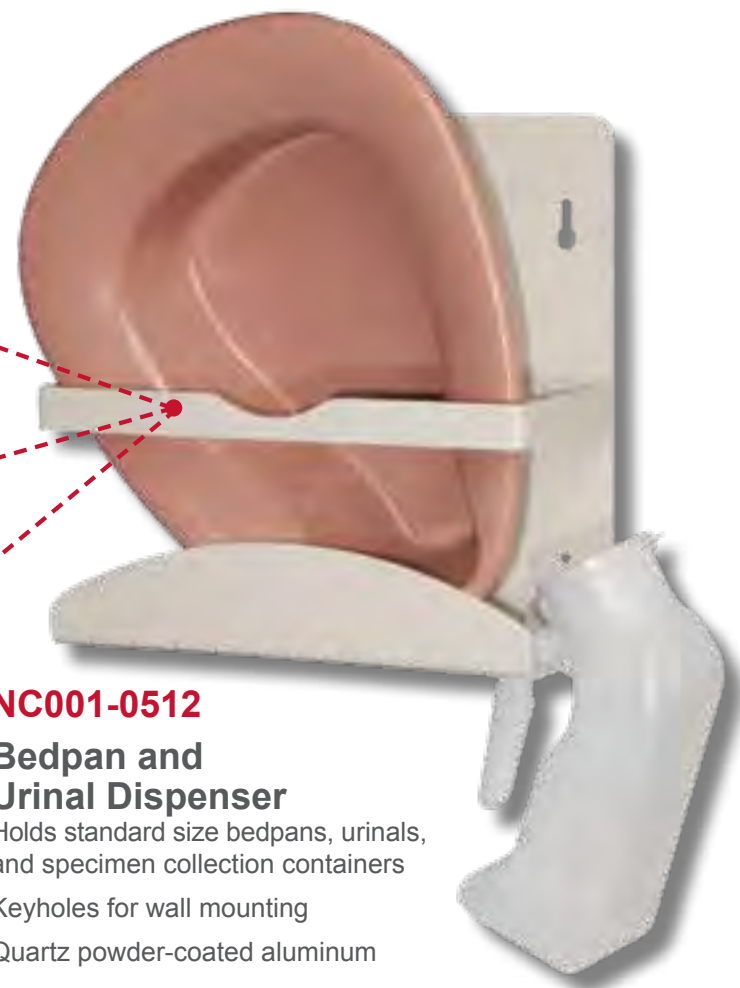

NC001-0512

Bedpan and Urinal Dispenser

Holds standard size bedpans, urinals, and specimen collection containers
Keyholes for wall mounting
Quartz powder-coated aluminum

BOWMAN® Bags on Demand

- Dispenses individual-sized linen and biohazard bags
- Available in single and double bag configurations as well as triple glove with bag section
- Quartz ABS or clear PETG plastic material coordinates with a diverse range of environments
- Two-way keyholes enable vertical or horizontal mounting options
- Will also accommodate garbage bags (12-16 gallon size)

All consumable items are for demonstration purposes only and are not available for purchase through BOWMAN®.

Part Number	Product Name	Page	Unit	W (L)	H	D	Product Weight
BB-001	Bouffant Cap or Shoe Cover Dispenser - White Powder-Coated Steel	35	IN	11 1/4	11 3/16	5 1/8	LB 2.25
			CM	28.6	28.3	13.0	KG 1.0
BB-034	Bouffant Cap or Shoe Cover Dispenser - White Powder-Coated Steel	43	IN	10 1/16	10	5 5/16	LB 2.15
			CM	25.6	25.4	13.5	KG 1.0
BG001-0111	Bag Dispenser - Single - Clear PETG Plastic	40	IN	10 1/8	3 5/8	3 15/16	LB 0.65
			CM	25.7	9.1	10.0	KG 0.3
BG001-0212	Bag Dispenser - Single - Quartz ABS Plastic	40	IN	10 1/8	3 5/8	3 15/16	LB 0.55
			CM	25.7	9.1	10.0	KG 0.2
BG002-0111	Bag Dispenser - Double - Clear PETG Plastic	40	IN	10 1/8	7 1/8	3 15/16	LB 1.15
			CM	25.7	18.0	10.0	KG 0.5
BG002-0212	Bag Dispenser - Double - Quartz ABS Plastic	40	IN	10 1/8	7 1/8	3 15/16	LB 0.95
			CM	25.7	18.0	10.0	KG 0.4
BK001-0300	Bulk Dispenser - Tall Single Bin - Stainless Steel	34	IN	12 3/16	17 1/16	5 3/4	LB 7.45
			CM	31.0	43.4	14.6	KG 3.4
BP-007	Bouffant Cap or Shoe Cover Dispenser - Clear PETG Plastic	35	IN	11 3/8	11 1/4	5 1/4	LB 1.00
			CM	28.9	28.5	13.4	KG 0.5
BP-011	Bulk Dispenser - Tall Single Bin - Clear PETG Plastic	33	IN	12 1/4	17	5 13/16	LB 3.10
			CM	31.2	43.3	14.8	KG 1.4
BP-012	Bulk Dispenser - Tall Double Bin - Clear PETG Plastic	33	IN	12 1/4	17	5 3/4	LB 3.45
			CM	31.2	43.2	14.7	KG 1.6
BP-021	Bulk Dispenser - Single Bin - Clear PETG Plastic	26, 33	IN	12 1/4	11 1/8	5 3/4	LB 2.20
			CM	31.2	28.3	14.7	KG 1.0
BP-022	Bulk Dispenser - Double Bin - Clear PETG Plastic	33	IN	12 1/4	11 1/8	5 3/4	LB 2.35
			CM	31.2	28.3	14.7	KG 1.1
BP-023	Bulk Dispenser - Triple Bin - Clear PETG Plastic	33	IN	17 1/2	11 3/16	6 1/16	LB 3.50
			CM	44.5	28.4	15.4	KG 1.6
BP-090	Bulk Dispenser - Tall Triple Bin - Clear PETG Plastic	33	IN	18 3/8	17 1/16	5 3/4	LB 4.95
			CM	46.7	43.4	14.7	KG 2.2
CL002-0111	Task Wipe Dispenser - Small - Clear PETG Plastic	37	IN	5 3/16	5 1/8	3 3/16	LB 0.30
			CM	13.2	13.0	8.1	KG 0.1
CL003-0111	Task Wipe Dispenser - Large - Clear PETG Plastic	37	IN	5 3/16	15 7/8	3 15/16	LB 1.00
			CM	13.2	40.3	10.0	KG 0.5
CP-071	Eyewear Dispenser - Open Top - Clear PETG Plastic	43	IN	9 1/16	4 3/4	6 11/16	LB 0.80
			CM	23.1	12.1	17.0	KG 0.4
CP-072	Eyewear Dispenser - Hinged Lid Top - Clear PETG Plastic	38	IN	9 1/4	3 7/16	6 15/16	LB 1.05
			CM	23.5	8.8	17.6	KG 0.5
CP-073	Eyewear Dispenser - Hinged Lid Top - Clear PETG Plastic	43	IN	9 1/4	5 11/16	9 9/16	LB 2.25
			CM	23.5	14.5	24.2	KG 1.0
CP-075	Eyewear Cabinet - Locking - White ABS Plastic with Clear PETG Plastic Locking Door	38	IN	13 1/2	20	4 1/8	LB 4.25
			CM	34.3	50.8	10.5	KG 1.9
CP-076	Eyewear Cabinet - Locking - White ABS Plastic with Clear PETG Plastic Locking Door	38	IN	20	20	5	LB 6.35
			CM	50.8	50.8	12.7	KG 2.9
ED-097	Infection Prevention Organizer - Quartz ABS Plastic and Clear PETG Plastic Sign Holder	18, 20	IN	15	11 3/8	5 3/4	LB 1.80
			CM	38.1	28.9	14.6	KG 0.8
ED-750	Epinephrine Injector Dispenser - 5 Injector Capacity - Quartz ABS Plastic and Clear PETG Plastic Door	41	IN	9	11 3/16	2 1/2	LB 1.85
			CM	22.9	28.4	6.4	KG 0.8

Part Number	Product Name	Page	Unit	W (L)	H	D	Product Weight
ED-760	Epinephrine Injector Dispenser - 10 Injector Capacity - Yellow Sintra Plastic and Clear PETG Plastic	41	IN	9 1/2	11 3/16	4 5/8	LB 2.40
			CM	24.1	28.4	11.8	KG 1.1
EP-105	Hearing Protection Dispenser - Single Bin - Clear PETG Plastic	38	IN	9 1/4	11 9/16	6 3/16	LB 1.95
			CM	23.5	29.3	15.7	KG 0.9
FB-001	Face Mask Dispenser - White Powder-Coated Steel	31, 32	IN	5 11/16	6 7/16	5 1/16	LB 1.00
			CM	14.5	16.3	12.9	KG 0.5
FB-002	Face Mask Dispenser - White Powder-Coated Steel	31, 32	IN	6 7/16	8 1/2	5 3/16	LB 1.35
			CM	16.4	21.7	13.1	KG 0.6
FB-003	Face Mask Dispenser - White Powder-Coated Steel	31, 32	IN	8 1/16	9	5 3/16	LB 1.65
			CM	20.5	22.9	13.2	KG 0.7
FB-004	Face Mask Dispenser - White Powder-Coated Steel	31, 32	IN	5 5/16	7 3/4	5 5/16	LB 1.22
			CM	13.5	19.8	13.5	KG 0.6
FB-005	Face Mask Dispenser - White Powder-Coated Steel	44	IN	9 9/16	7 3/16	3 9/16	LB 0.28
			CM	24.3	18.2	9.0	KG 0.1
FB-007	Face Mask Dispenser - White Powder-Coated Steel	31, 32	IN	5 7/8	10 11/16	5 1/16	LB 1.65
			CM	15.0	27.1	12.9	KG 0.7
FB-010	Face Mask Dispenser - N-95 Flat Style - White Powder-Coated Steel	31, 32	IN	10 7/16	4 1/8	4 13/16	LB 0.70
			CM	26.5	10.5	12.2	KG 0.3
FB-021	Face Mask Dispenser - Tie Style - White Powder-Coated Steel	27, 31, 32	IN	7 7/16	4 3/4	4 13/16	LB 0.85
			CM	18.9	12.1	12.2	KG 0.4
FB-037	Face Mask Dispenser - Earloop Style - White Powder-Coated Steel	27, 31, 32	IN	7 9/16	4 1/4	4 1/8	LB 0.65
			CM	19.2	10.8	10.5	KG 0.3
FB-039	Face Mask Dispenser - Tie Style - White Powder-Coated Steel	44	IN	7 13/16	7 1/2	5 1/4	LB 1.52
			CM	19.8	19.1	13.3	KG 0.7
FB-040	Face Mask Dispenser - Tie Style - White Powder-Coated Steel	44	IN	8	6	5 1/4	LB 1.30
			CM	20.3	15.2	13.3	KG 0.6
FB-041	Face Mask Bulk Dispenser - Bulk - White Powder-Coated Steel	44	IN	8 1/2	5	3 1/4	LB 0.95
			CM	21.6	12.6	8.3	KG 0.4
FB-063	Face Mask Dispenser - Tie Style - White Powder-Coated Steel	31, 32	IN	7 13/16	7 1/2	5 1/4	LB 1.35
			CM	19.8	19.1	13.3	KG 0.6
FB-064	Face Mask Dispenser - Earloop Style - White Powder-Coated Steel	31, 32	IN	7 9/16	4 1/4	4 1/8	LB 0.75
			CM	19.2	10.8	10.5	KG 0.3
FB-090	Face Mask Dispenser - Shield Style - White Powder-Coated Steel	27, 31, 32	IN	9 1/16	7 1/2	4 1/16	LB 1.15
			CM	23.0	19.1	10.3	KG 0.5
FB-091	Face Mask Dispenser - Tie Style - White Powder-Coated Steel	31, 32	IN	7 7/8	7 11/16	5	LB 1.20
			CM	20.1	19.6	12.7	KG 0.5
FD-005	Face Mask Dispenser - Bulk with Hinged Lid - White ABS Plastic and Clear PETG Plastic	27	IN	8 11/16	5	4 3/8	LB 0.95
			CM	22.0	12.6	11.1	KG 0.4
FD-010	Face Mask Dispenser - Bulk with Hinged Lid - White ABS Plastic and Clear PETG Plastic	27	IN	8 11/16	9 3/4	4 3/8	LB 1.50
			CM	22.0	24.7	11.1	KG 0.7
FD-062	Respiratory Hygiene Station - Locking - Quartz ABS Plastic and Clear PETG Plastic Lid	17	IN	17 1/2	10	5	LB 3.20
			CM	44.5	25.4	12.7	KG 1.5
FD-068	Infection Prevention Organizer - Quartz ABS Plastic	18, 20	IN	18 1/2	11 5/8	4 1/2	LB 2.05
			CM	47.0	29.5	11.4	KG 0.9
FD-111	Respiratory Hygiene Station - Quartz ABS Plastic	17	IN	19 3/4	13 7/8	5	LB 1.85
			CM	50.2	35.3	12.7	KG 0.8

Part Number	Product Name	Page	Unit	W (L)	H	D	Product Weight
FD-112	Respiratory Hygiene Station - Locking - Quartz ABS Plastic with Clear PETG Plastic Lid	17	IN	19 3/4	13 7/8	5 7/16	LB 2.70
			CM	50.2	35.3	13.8	KG 1.2
FM001-0213	Surgical Face Mask Dispenser - White ABS Plastic	28	IN	26 1/2	12 3/4	10 5/8	LB 8.85
			CM	67.3	32.4	27.0	KG 4.0
FM002-0213	Face Mask Combo Dispenser - White ABS Plastic	28	IN	10 5/8	23 1/2	4 15/16	LB 2.70
			CM	26.9	59.7	12.6	KG 1.2
FM003-0413	Face Mask Dispenser - White Powder-Coated Steel	45	IN	7 13/16	4 1/4	5 1/16	LB 0.85
			CM	19.8	10.8	12.9	KG 0.4
FP-007	Face Mask Dispenser - Clear PETG Plastic	29, 30	IN	6 9/16	8 1/2	5 5/16	LB 0.75
			CM	16.7	21.7	13.5	KG 0.3
FP-008	Face Mask Dispenser - Clear PETG Plastic	45	IN	8 3/16	9	5 5/16	LB 0.75
			CM	20.8	22.9	13.5	KG 0.3
FP-009	Face Mask Dispenser - Clear PETG Plastic	29, 30	IN	5 1/2	7 3/4	5 1/2	LB 0.60
			CM	14.0	19.8	14.0	KG 0.3
FP-010	Face Mask Dispenser - N-95 Flat Style - Clear PETG Plastic	29, 30	IN	9 11/16	7 3/16	3 11/16	LB 0.65
			CM	24.6	18.2	9.4	KG 0.3
FP-015	Face Mask Dispenser - Earloop Style - Clear PETG Plastic	29, 30	IN	10 9/16	4 1/8	4 15/16	LB 0.40
			CM	26.9	10.5	12.6	KG 0.2
FP-017	Face Mask Dispenser - Cone - Bulk - Clear PETG Plastic	27	IN	6 11/16	9	6 1/16	LB 1.35
			CM	17.0	22.8	15.3	KG 0.6
FP-021	Face Mask Dispenser - Earloop Style - Clear PETG Plastic	27, 29, 30	IN	7 15/16	4 1/4	5 3/16	LB 0.45
			CM	20.2	10.7	13.2	KG 0.2
FP-022	Face Mask Dispenser - Earloop Style - Clear PETG Plastic	29, 30	IN	8 1/8	7 3/4	4 15/16	LB 0.90
			CM	20.6	19.6	12.5	KG 0.4
FP-027	Eye Shield Dispenser - Clear PETG Plastic	35	IN	10 3/16	7 5/8	5 11/16	LB 0.69
			CM	25.9	19.3	14.5	KG 0.3
FP-028	Face Mask Dispenser - Clear PETG Plastic	29, 30	IN	7 11/16	5 5/8	5 3/16	LB 0.55
			CM	19.6	14.2	13.2	KG 0.2
FP-038	Face Mask Dispenser - Earloop Style - Clear PETG Plastic	29, 30	IN	7 11/16	4 5/16	4 1/4	LB 0.40
			CM	19.6	11.0	10.8	KG 0.2
FP-084	Face Mask Dispenser - Cone Style - Clear PETG Plastic	29, 30	IN	5 3/16	6 1/8	5 5/16	LB 0.50
			CM	13.1	15.5	13.5	KG 0.2
FP-119	Face Mask Dispenser - Cone Style - Clear PETG Plastic	29, 30	IN	4 11/16	6 1/2	4 11/16	LB 0.55
			CM	11.9	16.5	11.9	KG 0.2
FP-120	Face Mask Dispenser - Shield Style - Clear PETG Plastic	27, 29, 30	IN	9 3/16	7 1/2	4 3/16	LB 0.70
			CM	23.4	19.1	10.7	KG 0.3
FP-121	Face Mask Dispenser - Earloop Style - Clear PETG Plastic	29, 30	IN	7 11/16	4 3/8	4 1/8	LB 0.45
			CM	19.6	11.0	10.5	KG 0.2
FP-122	Face Mask Dispenser - Tie Style - Clear PETG Plastic	29, 30	IN	8 1/16	7 5/8	5 9/16	LB 0.75
			CM	20.5	19.3	14.2	KG 0.3
GB-001	Glove Box Dispenser - Single with Built-in Flexible Spring - White Powder-Coated Steel	21, 23	IN	5 5/8	9 15/16	3 13/16	LB 1.35
			CM	14.2	25.3	9.7	KG 0.6
GB-002	Glove Box Dispenser - Double - White Powder-Coated Steel	23	IN	10 9/16	10	3 13/16	LB 1.60
			CM	26.8	25.5	9.7	KG 0.7
GB-003	Glove Box Dispenser - Triple - White Powder-Coated Steel	23	IN	15 13/16	10	3 13/16	LB 1.75
			CM	40.2	25.5	9.7	KG 0.8

Part Number	Product Name	Page	Unit	W (L)	H	D	Product Weight
GB-027	Glove Box Dispenser - Food Service - White Powder-Coated Steel	26	IN	7 11/16	6 5/16	15/16	LB 0.65
			CM	19.6	16.0	2.3	KG 0.3
GB-059	Glove Box Dispenser - Quad - White Powder-Coated Steel	23	IN	22 5/16	10	3 13/16	LB 2.65
			CM	56.7	25.4	9.7	KG 1.2
GB-067	Glove Box Dispenser - Double - Space Saver - White Powder-Coated Steel	25	IN	5 5/8	20 1/16	3 15/16	LB 2.45
			CM	14.2	50.9	10.0	KG 1.1
GB-068	Glove Box Dispenser - Triple - Space Saver - White Powder-Coated Steel	25	IN	5 1/2	30 1/16	3 15/16	LB 3.45
			CM	14.0	76.3	10.0	KG 1.6
GB-074	Glove Box Dispenser - Single - Large Capacity with Flexible Spring - White Powder-Coated Steel	26	IN	6 1/2	9 15/16	3 13/16	LB 1.55
			CM	16.5	25.3	9.7	KG 0.7
GD-011	Glove Box Caddy - Single - Quartz ABS Plastic	5, 11	IN	10	5 5/8	4 1/8	LB 0.55
			CM	25.4	14.3	10.5	KG 0.2
GD-012	Glove Box Caddy - Double - Quartz ABS Plastic	5, 11	IN	22 5/8	5 5/8	4 1/8	LB 1.25
			CM	57.5	14.3	10.5	KG 0.6
GD-042	Glove Box Dispenser - Double with Divider - Quartz ABS Plastic	23, 24	IN	11 3/8	9 15/16	3 3/4	LB 1.24
			CM	28.9	25.2	9.5	KG 0.6
GD-111	Glove Box Caddy - Single with Shelf - Quartz ABS Plastic	5, 11	IN	22 5/8	5 5/8	4 1/8	LB 1.25
			CM	57.5	14.3	10.5	KG 0.6
GL031-0413	Glove Box Dispenser - Triple - Deep - White Powder-Coated Steel	26	IN	15 3/8	10 1/16	4 9/16	LB 2.22
			CM	39.0	25.5	11.6	KG 1.0
GL041-0212	Glove Box Dispenser - Quad - For Sterile Gloves - Quartz ABS Plastic	26	IN	22 11/16	13 3/8	6 3/16	LB 1.64
			CM	57.7	33.9	15.7	KG 0.7
GL042-0212	Glove Box Dispenser - Quad with Shelf - Quartz ABS Plastic	23, 24, 26	IN	20 1/8	12 5/16	3 15/16	LB 2.20
			CM	51.1	31.2	10.0	KG 1.0
GL100-0212	Glove Box Dispenser - Single - Quartz ABS Plastic	22, 23	IN	5 13/16	10 1/8	4 1/4	LB 0.70
			CM	14.8	25.7	10.7	KG 0.3
GL100-1214	Glove Box Dispenser - Single - Semi-Transparent Polycarbonate Plastic	23	IN	5 13/16	10 1/8	4 1/4	LB 0.70
			CM	14.8	25.7	10.7	KG 0.3
GL300-0212	Glove Box Dispenser - Triple with Dividers - Quartz ABS Plastic	23, 24	IN	17 1/16	10 1/8	4 1/4	LB 1.40
			CM	43.4	25.7	10.7	KG 0.6
GL300-1214	Glove Box Dispenser - Triple with Dividers - Semi-Transparent Polycarbonate Plastic	22, 23, 24	IN	17 1/16	10 1/8	4 1/4	LB 1.40
			CM	43.4	25.7	10.7	KG 0.6
GN001-0212	Gown Dispenser - Quartz ABS Plastic	33	IN	14 11/16	15 1/8	5 1/16	LB 2.83
			CM	37.3	38.4	12.8	KG 1.3
GN002-0212	Gown Dispenser - Launderable - Quartz ABS Plastic	46	IN	14 3/4	28 3/16	5 3/16	LB 5.25
			CM	37.5	71.6	13.1	KG 2.4
GN100-0212	Gown Dispenser - Universal Thumbs-Up - Quartz ABS Plastic	34	IN	7 15/16	9 7/8	4 15/16	LB 1.01
			CM	20.2	25.0	12.6	KG 0.5
GP-013	Glove Box Dispenser - Single with Flexible Spring - Clear PETG Plastic	46	IN	5 11/16	9 7/8	3 15/16	LB 0.70
			CM	14.5	25.0	10.0	KG 0.3
GP-014	Glove Box Dispenser - Double - Clear PETG Plastic	23	IN	10 11/16	10 1/8	3 15/16	LB 0.85
			CM	27.2	25.7	10.0	KG 0.4
GP-015	Glove Box Dispenser - Triple - Clear PETG Plastic	46	IN	15 15/16	10 1/8	3 15/16	LB 0.95
			CM	40.5	25.7	10.0	KG 0.4
GP-020	Glove Box Dispenser - Single - Large Capacity with Flexible Spring - Clear PETG Plastic	26	IN	6 5/8	10	4	LB 0.85
			CM	16.9	25.5	10.2	KG 0.4

Part Number	Product Name	Page	Unit	W (L)	H	D	Product Weight
GP-025	Glove Box Dispenser - Food Service - Clear PETG Plastic	26	IN	8 5/16	7	1 1/8	LB 0.40
			CM	21.1	17.8	2.9	KG 0.2
GP-042	Glove Box Dispenser - Double with Divider - Clear PETG Plastic	24	IN	11 5/16	9 7/8	3 11/16	LB 1.35
			CM	28.7	25.1	9.4	KG 0.6
GP-061	Glove Box Dispenser - Quad - Clear PETG Plastic	23	IN	22 7/16	10	3 7/8	LB 1.15
			CM	57.0	25.5	9.9	KG 0.5
GP-106	Glove Box Dispenser - Double - Space Saver - Clear PETG Plastic	25	IN	5 11/16	20 1/8	4 1/16	LB 1.35
			CM	14.5	51.1	10.4	KG 0.6
GP-107	Glove Box Dispenser - Triple - Space Saver - Clear PETG Plastic	25	IN	5 1/2	30 1/8	3 15/16	LB 1.95
			CM	14.0	76.5	10.0	KG 0.9
GP-120	Chemotherapy Glove Box Dispenser - Single - Clear PETG Plastic	26	IN	10 7/16	10 3/4	4 7/16	LB 1.05
			CM	26.5	27.3	11.3	KG 0.5
GP-310	Glove Box Dispenser - Single - Clear PETG Plastic	25	IN	11 3/16	4 7/8	3 11/16	LB 0.65
			CM	28.4	12.3	9.4	KG 0.3
GP-320	Glove Box Dispenser - Double - Clear PETG Plastic	25	IN	11 3/16	9 5/8	3 11/16	LB 1.20
			CM	28.4	24.4	9.4	KG 0.5
GP-330	Glove Box Dispenser - Triple - Clear PETG Plastic	25	IN	11 3/16	14 3/8	3 11/16	LB 1.65
			CM	28.4	36.4	9.4	KG 0.7
GP-340	Glove Box Dispenser - Quad - Clear PETG Plastic	25	IN	11 3/16	19 1/8	3 11/16	LB 2.25
			CM	28.4	48.5	9.4	KG 1.0
GS-004	Glove Box Dispenser - Single with Flexible Spring - Stainless Steel	21, 23	IN	5 5/8	9 15/16	3 13/16	LB 1.35
			CM	14.2	25.3	9.7	KG 0.6
GS-005	Glove Box Dispenser - Double - Stainless Steel	23	IN	10 9/16	10 1/16	3 13/16	LB 1.40
			CM	26.8	25.5	9.7	KG 0.6
GS-006	Glove Box Dispenser - Triple - Stainless Steel	23	IN	15 13/16	10 1/16	3 13/16	LB 1.80
			CM	40.2	25.5	9.6	KG 0.8
GS-026	Glove Box Dispenser - Food Service - Stainless Steel	26	IN	7 11/16	6 5/16	15/16	LB 0.65
			CM	19.6	16.0	2.3	KG 0.3
GS-060	Glove Box Dispenser - Quad - Stainless Steel	23	IN	22 5/16	10	3 13/16	LB 2.35
			CM	56.7	25.4	9.7	KG 1.1
GS-073	Glove Box Dispenser - Single - Large Capacity with Flexible Spring - Stainless Steel	26	IN	6 1/2	9 15/16	3 13/16	LB 1.50
			CM	16.5	25.3	9.7	KG 0.7
GS-108	Glove Box Dispenser - Double - Space Saver - Stainless Steel	25	IN	5 5/8	20	3 15/16	LB 2.35
			CM	14.2	50.9	10.0	KG 1.1
GS-109	Glove Box Dispenser - Triple - Space Saver - Stainless Steel	25	IN	5 1/2	30 1/16	3 15/16	LB 3.55
			CM	14.0	76.3	10.0	KG 1.6
GS-122	Glove Box Dispenser - Double with Divider - Stainless Steel	24	IN	10 9/16	10	3 13/16	LB 1.75
			CM	26.9	25.5	9.7	KG 0.8
GS-123	Glove Box Dispenser - Triple with Dividers - Stainless Steel	21, 24	IN	15 7/8	10	3 13/16	LB 2.25
			CM	40.3	25.5	9.7	KG 1.0
GS-124	Glove Box Dispenser - Quad with Dividers - Stainless Steel	24	IN	21 3/16	10	3 13/16	LB 2.40
			CM	53.7	25.5	9.7	KG 1.1
GW-029	Glove Box Dispenser - Single - Vertical or Horizontal Wall Mounting - White Coated Wire	23	IN	11 7/16	4 1/8	4 3/16	LB 0.75
			CM	29.1	10.5	10.7	KG 0.3
GW-040	Glove Box Dispenser - Double - Mounts Vertically - Holds Gloves Horizontally - White Coated Wire	23	IN	11 5/8	11 5/8	3 15/16	LB 1.30
			CM	29.5	29.5	10.0	KG 0.6

Part Number	Product Name	Page	Unit	W (L)	H	D	Product Weight
GW-045	Glove Box Dispenser - Double - Mounts Horizontally - Holds Glove Boxes Vertically - White Coated Wire	48	IN	11 1/2	8	4 1/8	LB 0.95
			CM	29.2	20.3	10.4	KG 0.4
GW-050	Glove Box Dispenser - Triple - Mounts Vertically - Holds Glove Boxes Horizontally - White Coated Wire	23	IN	11 5/8	22 5/8	3 15/16	LB 1.52
			CM	29.5	36.2	10.0	KG 0.7
GW-055	Glove Box Dispenser - Triple - Mounts Horizontally - Holds Glove Boxes Vertically - White Coated Wire	48	IN	16 1/2	8	4 1/8	LB 1.25
			CM	41.9	20.3	10.4	KG 0.6
GW-060	Glove Box Dispenser - Quad - Mounts Vertically - Holds Glove Boxes Horizontally - White Coated Wire	48	IN	11 5/8	22 5/8	3 15/16	LB 1.55
			CM	29.5	57.5	10.0	KG 0.7
GW-065	Glove Box Dispenser - Quad - Mounts Horizontally - Holds Glove Boxes Vertically - White Coated Wire	23	IN	22 1/2	8	4 1/8	LB 2.05
			CM	57.2	20.3	10.4	KG 0.9
HP-010	Hairnet Dispenser - Clear PETG Plastic	48	IN	4 7/16	8	3 15/16	LB 0.65
			CM	11.3	20.3	10.0	KG 0.3
KS010-0412	Floor Stand - All Steel with Standard Base - Quartz Powder-Coated Steel	15, 16	IN	18	36 1/16	18	LB 16.00
			CM	45.7	91.6	45.7	KG 7.2
KS102-0029	Hand Sanitizer Floor Stand - Bay Gray Steel Back Plate, Column, and Base - Quartz ABS Plastic Drip Tray	19	IN	18	54 3/4	18	LB 16.20
			CM	45.7	139.0	45.7	KG 7.30
KS201-0029	Floor Stand - Bay Gray Powder-Coated Steel Mounting Plate, Column, and Base	20	IN	18	36 3/4	18	LB 15.25
			CM	45.7	93.3	45.7	KG 6.9
LB001-0111	Bio-Shield - Large - Clear PETG Plastic	37	IN	11 1/2	15	7 1/2	LB 1.20
			CM	29.2	38.1	19.1	KG 0.5
LB002-0111	Bio-Shield - Small - Clear PETG Plastic	37	IN	8	9	5	LB 0.55
			CM	20.3	22.9	12.7	KG 0.2
LD-007	Protection Organizer - Quartz ABS Plastic	5, 11	IN	16 5/8	25 1/4	4 1/2	LB 3.85
			CM	42.2	64.1	11.4	KG 1.7
LD-037	Protection Organizer - Quartz ABS Plastic	3, 5, 9, 10, 11	IN	22 3/4	20 1/2	4 3/4	LB 4.25
			CM	57.8	52.1	12.0	KG 1.9
LD-040	Protection Organizer - Gloveless - Quartz ABS Plastic and Clear PETG Plastic	6	IN	22 3/4	15	4 3/4	LB 3.50
			CM	57.8	38.1	12.0	KG 1.6
LD-062	Protection Organizer - 4" Deep - Double Gown - Quartz ABS Plastic	4, 5, 11	IN	22 1/4	30 3/4	4	LB 6.20
			CM	56.5	78.1	10.2	KG 2.8
LD-063	Protection Organizer - Double Gown - Quartz ABS Plastic	48	IN	19 11/16	30	4 3/4	LB 5.30
			CM	50.0	76.1	12.1	KG 2.4
LD-064	Protection Organizer - 4" Deep - Quartz ABS Plastic	6, 11	IN	16 3/4	25 5/8	4	LB 3.70
			CM	42.5	65.1	10.2	KG 1.7
LD-067	Protection Organizer - Launderable Gowns - Quartz ABS Plastic	6, 12	IN	19 11/16	28 5/8	4 3/4	LB 5.25
			CM	50.0	72.7	12.1	KG 2.4
LD-070	Protection Organizer - Quartz ABS Plastic	5, 12	IN	20 1/16	25 1/4	4 3/4	LB 4.30
			CM	50.9	64.1	12.1	KG 2.0
LP-004	Protection Organizer - Quartz ABS Plastic and Clear PETG Plastic	35	IN	22 1/8	19 11/16	4 7/8	LB 4.75
			CM	56.3	50.0	12.4	KG 2.2
MA-205	Shelf - White Powder-Coated Aluminum	48	IN	11 1/4	7 9/16	15 1/8	LB 2.75
			CM	28.6	19.2	38.5	KG 1.2
MB-085	Infection Prevention Organizer - Bronze Powder-Coated Steel	27	IN	9 7/8	10 1/8	4 3/16	LB 2.60
			CM	25.0	25.7	10.6	KG 1.2
MB-450	Door Hanger for Metal Bracketed Fire Doors - Quartz Powder-Coated Steel	10	IN	34	17 11/16	3 1/16	LB 2.45
			CM	86.4	44.9	7.8	KG 1.1

Part Number	Product Name	Page	Unit	W (L)	H	D	Product Weight
MB-500	Door Hanger - For Glass Doors - Quartz Powder-Coated Steel	10	IN	22	4 5/8	9/16	LB 0.95
			CM	55.9	11.7	1.4	KG 0.4
MB-510	Wall Hanger - Quartz Powder-Coated Steel	9	IN	5 1/2	2 5/8	9/16	LB 0.20
			CM	14.0	6.7	1.4	KG 0.1
MB-600	Door Hanger - Standard - Quartz Powder-Coated Steel	10	IN	5 1/2	12 1/8	2 1/2	LB 1.05
			CM	14.0	30.8	6.4	KG 0.5
MB-601	Door Hanger - Long - Quartz Powder-Coated Steel	10	IN	5 1/2	19	2 1/2	LB 1.40
			CM	14.0	48.3	6.4	KG 0.6
MD-015	Hand Gel Bottle Holder - White ABS Plastic	20	IN	4	6 11/16	3 3/8	LB 0.15
			CM	10.2	16.9	8.6	KG 0.1
MD-100	Dental Organizer - Quartz ABS Plastic and Bronze PETG Plastic	41	IN	18 1/8	23 1/2	5 1/16	LB 4.40
			CM	46.0	59.7	12.9	KG 2.0
MP-015	Caddy Dispenser - Clip-On - Clear PETG Plastic	8, 11, 12	IN	6 3/16	7 5/16	6 5/8	LB 0.85
			CM	15.7	18.6	16.9	KG 0.4
MP-042	Caddy Dispenser - Clip-On - Clear PETG Plastic	8, 11,12	IN	4 7/16	4 1/16	5 1/8	LB 0.45
			CM	11.3	10.3	13.1	KG 0.2
MP-047	Sign Holder - Clip-On - Clear PETG Plastic	7, 8	IN	8 1/2	11 3/16	5/8	LB 0.90
			CM	21.6	28.4	1.6	KG 0.4
MP-070	Sign Holder - Vertical - Clear PETG Plastic	13, 14, 16, 17, 20	IN	8 5/8	13 13/16	5/16	LB 1.10
			CM	21.9	35.0	0.8	KG 0.5
MP-075	Sign Holder - Horizontal - Clear PETG Plastic	16, 18	IN	11 1/4	11 5/16	5/16	LB 1.15
			CM	28.6	28.7	0.8	KG 0.5
MP-085	Caddy Dispenser - Clip-On - Clear PETG Plastic	7, 8, 11, 12	IN	4 13/16	8 1/8	5 1/16	LB 0.90
			CM	12.2	20.6	12.8	KG 0.4
MW-001	Biohazard Bag Holder - One Gallon - White Coated Wire	37	IN	9 1/2	12 7/8	6 1/4	LB 1.65
			CM	24.1	32.7	15.9	KG 0.7
MW-003	Biohazard Bag Holder - Three Gallon - White Coated Wire	37	IN	11 3/4	15 1/4	8	LB 2.10
			CM	29.8	38.7	20.3	KG 1.0
MW-005	Biohazard Bag Holder - Five Gallon - White Coated Wire	37	IN	13 1/2	19 1/2	8 1/2	LB 2.70
			CM	34.3	49.5	21.6	KG 1.2
NC001-0512	Bedpan/Urinal Dispenser - Quartz Powder-Coated Aluminum	39	IN	12 5/16	12	4 11/16	LB 1.85
			CM	31.3	30.5	11.8	KG 0.8
PS003-0212	Protection Organizer - Left Side Gown Opening - Quartz ABS Plastic	6	IN	15	22	4 1/2	LB 3.00
			CM	38.1	55.9	11.4	KG 1.4
PS004-0111	Triple Glove & Single Roll Bag Dispenser - Clear PETG Plastic	40	IN	10 1/8	20 3/8	3 15/16	LB 2.75
			CM	25.7	51.8	10.0	KG 1.2
PS004-0212	Triple Glove & Single Roll Bag Dispenser - Quartz ABS Plastic	40	IN	10 1/8	20 3/8	3 15/16	LB 2.30
			CM	25.7	51.8	10.0	KG 1.0
PS007-0212	Protection Organizer - Double Gown - Quartz ABS Plastic	6, 12	IN	20	20 15/16	4 15/16	LB 3.93
			CM	50.8	53.2	12.6	KG 1.8
PS012-0512	Protection Organizer - All Aluminum - Quad Glove - Quartz Powder-Coated Aluminum	7, 8, 12	IN	22 3/4	25 5/8	4 9/16	LB 7.25
			CM	57.8	65.1	11.6	KG 3.3
QB-001	Cup Dispenser - White Powder-Coated Steel	49	IN	3	8 1/2	3	LB 1.00
			CM	7.6	21.6	7.6	KG 0.5
RC001-0111	Bag Valve Mask Dispenser - Clear PETG Plastic and Quartz Powder-Coated Aluminum	36	IN	21 1/4	18 1/4	6 1/4	LB 8.40
			CM	54.0	46.4	15.9	KG 3.8

Part Number	Product Name	Page	Unit	W (L)	H	D	Product Weight
RD-009	Gown Dispenser - Custom-Fold Gown - Quartz ABS Plastic	33	IN	12 11/16	21	3 7/8	LB 2.92
			CM	32.3	53.3	9.8	KG 1.3
RD-060	Protection Organizer - Custom-Fold Gown - Quartz ABS Plastic	6, 12	IN	22 7/8	21	3 7/8	LB 5.32
			CM	58.1	53.4	9.9	KG 2.4
RG-006	Quick Reference Card for Transmission Based Precautions - Horizontal - PVC Plastic	8	IN	3 3/8	2 1/4	1/16	LB .01
			CM	8.6	5.7	0.2	KG -
RG-008	Quick Reference Card for Transmission Based Precautions - Vertical - PVC Plastic	8	IN	2 1/4	3 3/8	1/16	LB .01
			CM	5.7	8.6	0.2	KG -
RP-011	Gown Dispenser - Clear PETG Plastic Face with White ABS Plastic Back	33	IN	14 11/16	15 1/8	5 1/16	LB 3.10
			CM	37.3	38.4	12.8	KG 1.4
RP-030	Gown Dispenser - Thumbs-Up - Clear PETG Plastic	33	IN	7 15/16	9 7/8	4 3/4	LB 0.85
			CM	20.2	25.0	12.0	KG 0.4
RS001-0212	Respiratory Hygiene Station - Quartz ABS Plastic	14, 15, 16, 17, 20, 27	IN	17 7/8	10 1/2	4 7/16	LB 1.70
			CM	45.5	26.7	11.3	KG 0.8
RS002-0212	Respiratory Hygiene Station - Locking - Quartz ABS Plastic	17	IN	13 13/16	12 5/8	5 5/16	LB 1.95
			CM	35.1	32.1	13.5	KG 0.9
SD-010	Surgical Apparel Organizer - Clear PETG Plastic and White ABS Plastic	35	IN	12 3/8	30 11/16	6 1/2	LB 5.85
			CM	31.4	78.0	16.5	KG 2.7
SP-003	Shoe Cover Dispenser - Clear PETG Plastic	35	IN	10 1/2	10 3/8	7	LB 1.10
			CM	26.7	26.3	17.7	KG 0.5
SP-573	Shoe Cover Dispenser - Clear PETG Plastic	35	IN	12 3/8	10 3/8	2 7/16	LB 0.95
			CM	31.5	26.3	6.2	KG 0.4
SS001-0212	Eye & Ear Safety Station - Quartz ABS Plastic	38	IN	18	10 7/8	5 3/8	LB 2.32
			CM	45.7	27.6	13.6	KG 1.1
TB-002	Towel Dispenser - White Powder-Coated Steel	37	IN	11 1/4	8 3/4	3 3/4	LB 2.0
			CM	28.6	22.2	9.5	KG 0.9
TB-003	Towel Dispenser - White Powder-Coated Steel	37	IN	11 1/4	15 1/4	3 3/4	LB 3.85
			CM	28.6	38.7	9.5	KG 1.7
TP-010	Towel Dispenser - Clear PETG Plastic	50	IN	11 3/8	11 1/4	4 3/16	LB 1.46
			CM	29.0	28.5	10.7	KG 0.7
WP-110	Bottle Holder - Clear PETG Plastic	20, 41	IN	4	3 7/8	4 5/16	LB 0.30
			CM	10.2	9.8	11.0	KG 0.1

Notes
