



## Econo Instruments

Econo instruments are made from the highest quality material to offer the identical function of a reusable instrument, but at an affordable cost. These disposable instruments are a convenient, dependable choice. They reduce the risk of cross contamination, saves labor cost and eliminates cleaning and sterilization processes.

- RELIABLE FUNCTION
- OVER 100 PATTERNS AVAILABLE
- FACTORY IS ISO 9000 CERTIFIED AND CGMP COMPLIANT



FLOOR GRADE SCISSORS



OPERATING SCISSORS

STRAIGHT

21-263	4½"	Sharp/Blunt	12/bx
21-266	4½"	Sharp/Sharp	12/bx
21-270	5"	Sharp/Blunt	12/bx
21-271	5"	Sharp/Sharp	12/bx
21-272	5½"	Sharp/Blunt	12/bx
21-275	5½"	Sharp/Sharp	12/bx
21-278	5½"	Blunt/Blunt	12/bx
21-281	6½"	Sharp/Blunt	12/bx
21-284	6½"	Sharp/Sharp	12/bx
21-288	6½"	Blunt/Blunt	12/bx



OPERATING SCISSORS

CURVED

21-291	4½"	Sharp/Blunt	12/bx
21-294	4½"	Sharp/Sharp	12/bx
21-299	5½"	Blunt/Blunt	12/bx
21-292	5½"	Sharp/Blunt	12/bx
21-295	5½"	Sharp/Sharp	12/bx
21-300	6½"	Blunt/Blunt	12/bx
21-293	6½"	Sharp/Blunt	12/bx



MAYO SCISSORS

21-308	5½"	Straight	12/bx
21-312	5½"	Curved	12/bx
21-321	6¾"	Straight	12/bx
21-325	6¾"	Curved	12/bx



MAYO DISSECTING SCISSORS

21-327	9"	Straight	12/bx
21-328	9"	Curved	12/bx

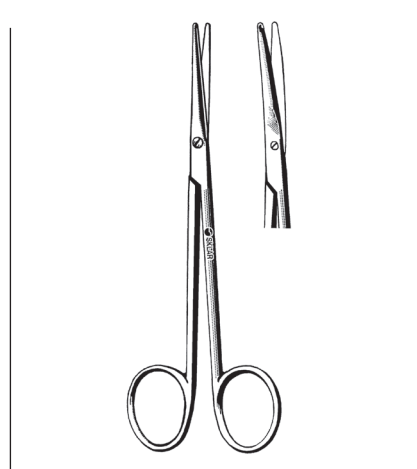

METZENBAUM SCISSORS

21-344	4½"	Curved	Lahey	12/bx
21-335	5½"	Straight	Lahey	12/bx
21-336	5½"	Curved	Lahey	12/bx
21-339	7"	Straight		12/bx
21-340	7"	Curved		12/bx
21-354	9"	Curved		12/bx



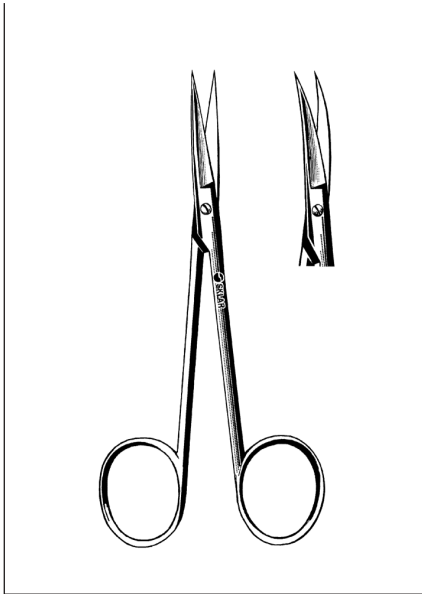

**IRIS SCISSORS**

21-102	2½"	Straight	12/bx
21-103	3½"	Straight	12/bx
21-107	3½"	Curved	12/bx
21-104	4½"	Straight	12/bx
21-109	4½"	Curved	12/bx



**SPENCER STITCH SCISSORS**

21-346	3½"	12/bx
21-352	4½"	12/bx

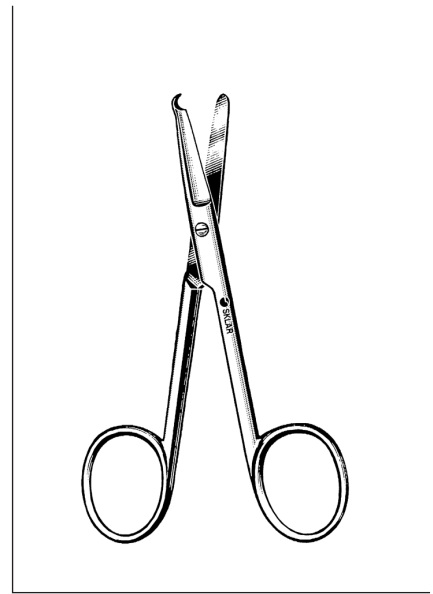

**LITTAUER STITCH SCISSOR**

21-358	5½"	12/bx
--------	-----	-------

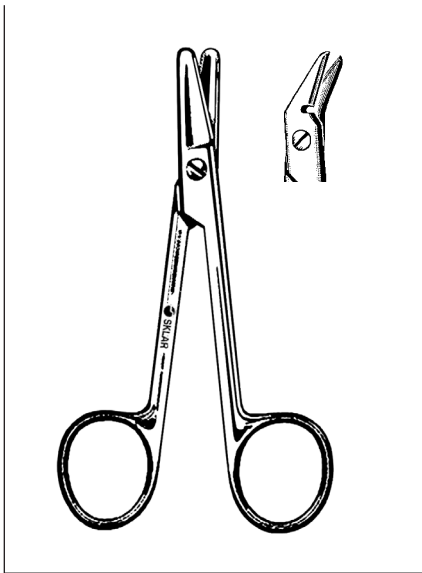

**WIRE CUTTING SCISSORS**

21-363	4½"	Straight	12/bx
21-364	4¾"	Angled	12/bx

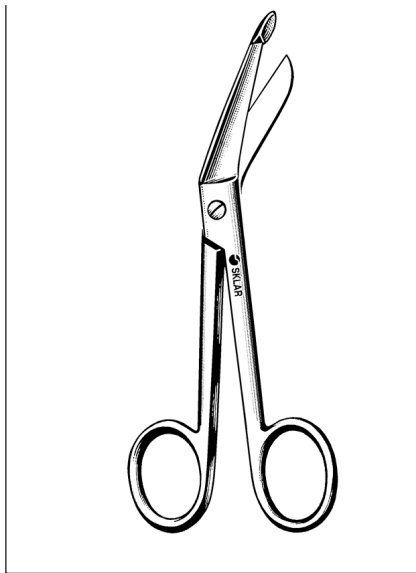

**LISTER BANDAGE SCISSORS**

21-222	3½"	12/bx
21-226	4½"	12/bx
21-231	5½"	12/bx
21-237	5½"	With Clip 12/bx
21-241	7¼"	12/bx
21-243	8"	12/bx
21-245	8"	Large Ring 12/bx

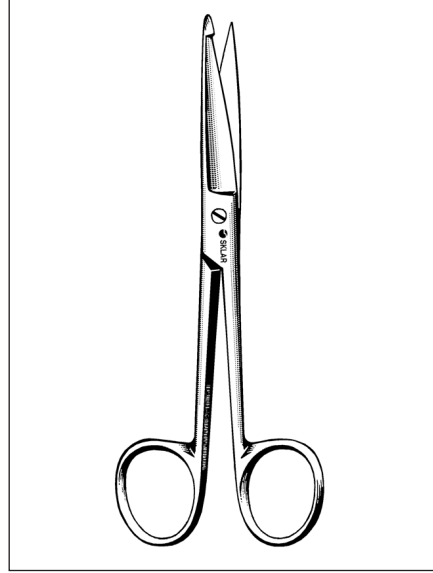

**KNOWLES BANDAGE SCISSOR**

21-254	5½"	12/bx
--------	-----	-------



FLOOR GRADE SCISSORS

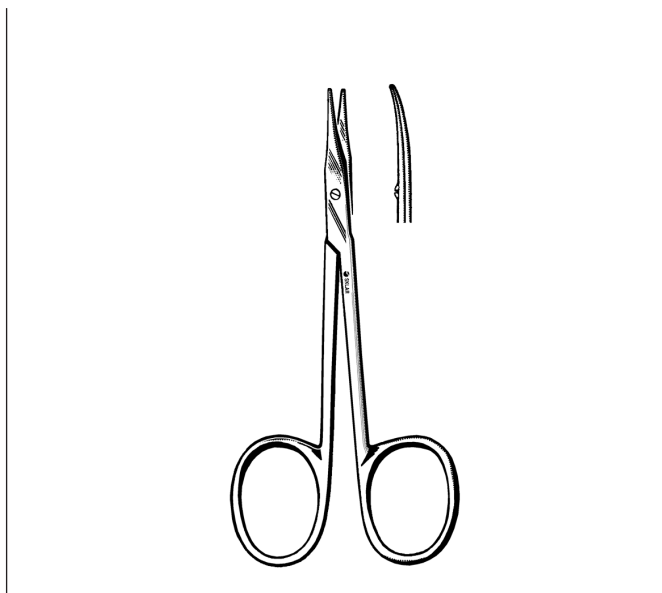

**STEVENS TENOTOMY SCISSORS**

21-160	4½"	Straight	Blunt/Blunt	12/bx
21-161	4½"	Curved	Blunt/Blunt	12/bx



**SUTURE SCISSOR**

21-369	3½"	Shortbent	12/bx
--------	-----	-----------	-------



**UTILITY SCISSORS**

21-101	5½"	Black	12/bx	21-105LG	7"	Lime Green	12/bx	21-105PR	7"	Purple	12/bx
21-100	6"	Blue	12/bx	21-105MG	7"	Magenta	12/bx	21-105RB	7"	Royal Blue	12/bx
21-105	7"	Black	12/bx	21-105NB	7"	Navy Blue	12/bx	21-105TB	7"	Teal Blue	12/bx
21-105BG	7"	Burgundy	12/bx	21-105OR	7"	Orange	12/bx	21-105YL	7"	Yellow	12/bx
21-105HG	7"	Hunter Green	12/bx								

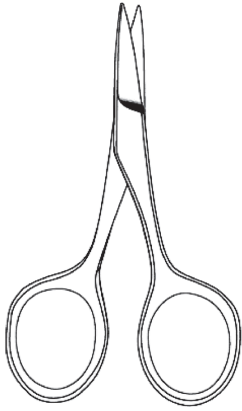

**SMALL UTILITY SCISSOR**

21-060 2½" 12/bx

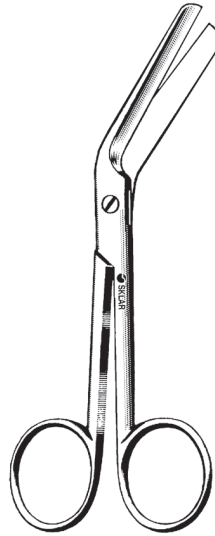

**BRAUN EPISIOTOMY SCISSOR**

21-375 5½" Angled 12/bx

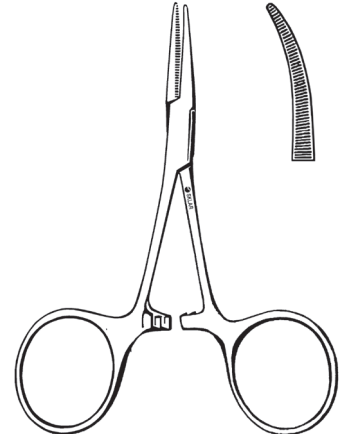

**HARTMANN MOSQUITO FORCEPS**

21-409 3½" Straight 12/bx  
21-421 3½" Curved 12/bx

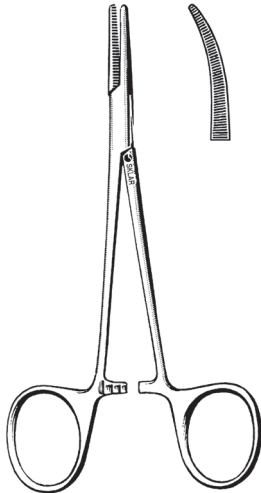

**HALSTED MOSQUITO FORCEPS**

21-426 5" Straight 12/bx  
21-431 5" Curved 12/bx

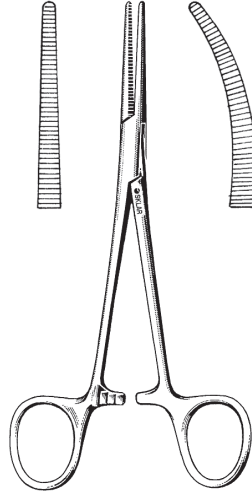

**CRILE HEMOSTATIC FORCEPS**

21-447 5½" Straight 12/bx  
21-452 5½" Curved 12/bx

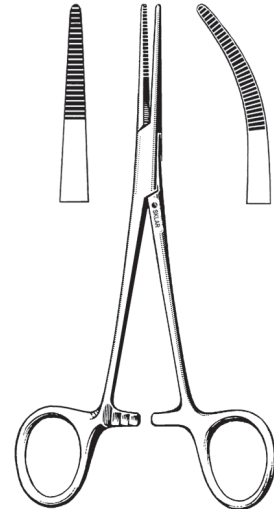

**KELLY HEMOSTATIC FORCEPS**

21-436 5½" Straight 12/bx  
21-442 5½" Curved 12/bx

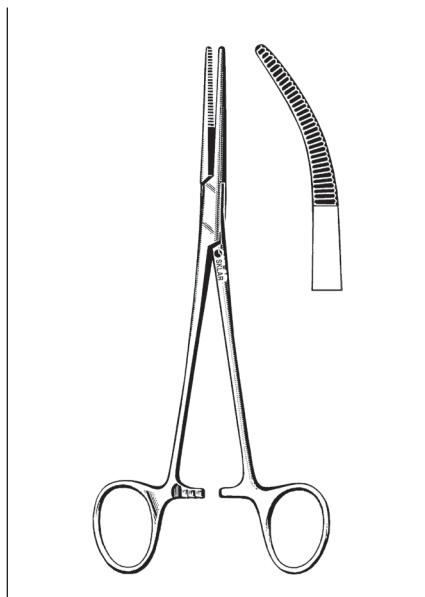

**RANKIN CRILE FORCEPS**

21-458	6¼"	Straight	12/bx
21-463	6¼"	Curved	12/bx

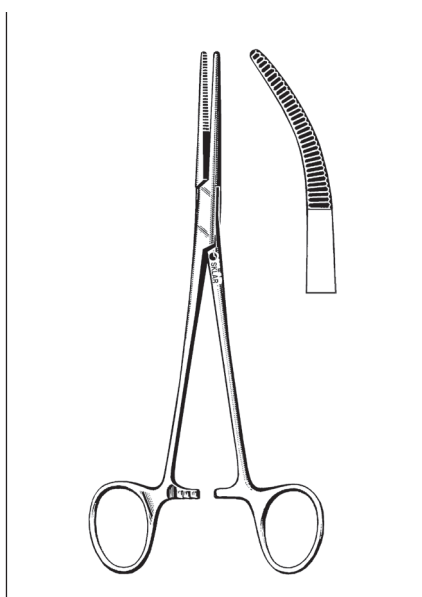

**RANKIN KELLY FORCEPS**

21-469	6¼"	Curved	12/bx
21-465	6½"	Straight	12/bx

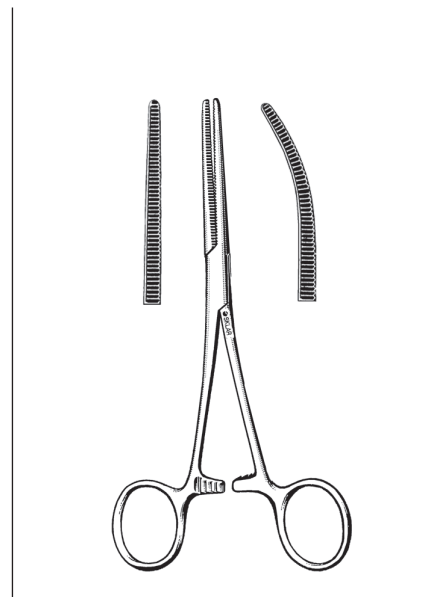

**ROCHESTER-PEAN FORCEPS**

STRAIGHT			CURVED		
21-470	5½"	12/bx	21-471	5½"	12/bx
21-473	6¼"	12/bx	21-477	6¼"	12/bx
21-481	7¼"	12/bx	21-495	6¾"	12/bx
21-492	8"	12/bx	21-485	7¼"	12/bx
			21-498	8"	12/bx
			21-487	9"	12/bx

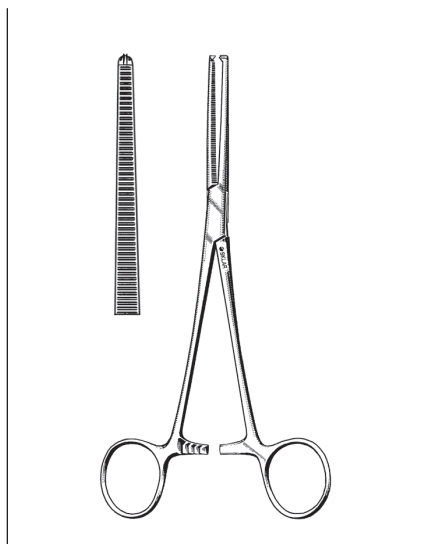

**ROCHESTER-OSHSNER  
FORCEPS**

**1X2 TEETH, STRAIGHT**

21-500	5½"	Kocher	12/bx
21-504	6¼"	Kocher	12/bx
21-488	7¼"		12/bx
21-513	8"		12/bx

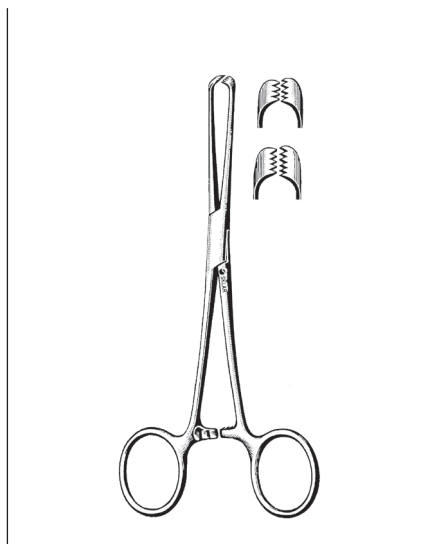

**ALLIS TISSUE FORCEPS**

21-930	6"	4x5 Teeth	12/bx
21-934	6"	5x6 Teeth	12/bx
21-941	6"	Atraumatic Jaw	12/bx
21-938	7½"	5x6 Teeth	12/bx

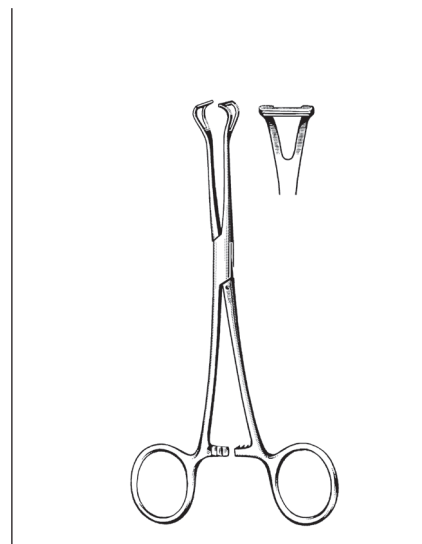

**BABCOCK FORCEPS**

21-952	6¼"	9mm	12/bx
21-441	8"	10mm	12/bx

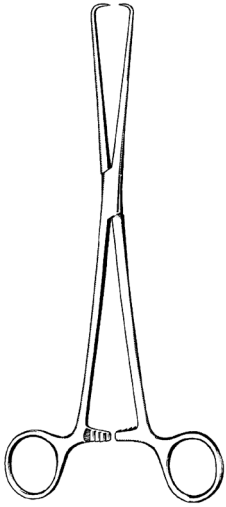

**SCHROEDER TENACULUM  
FORCEPS**

21-386 9¾" (Braun) 12/bx  
21-459 10¼" (Pozzi) 12/bx

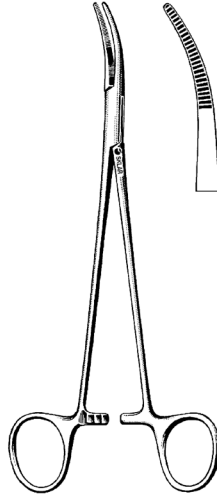

**SCHNIDT TONSIL  
HEMOSTATIC FORCEPS**

**HALF CURVE**  
21-434 7½" 12/bx

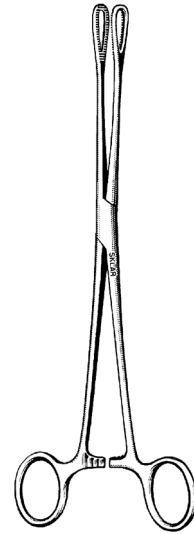

**SCHWEIZER FORCEPS**

21-437 9½" 12/bx

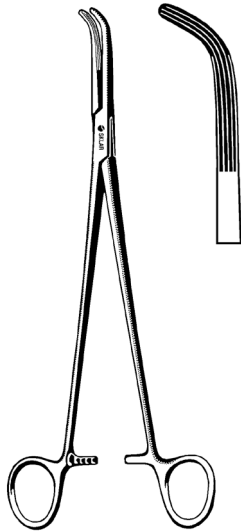

**LAHEY GALL DUCT FORCEPS**  
**LONGITUDINAL SERRATIONS**

21-453 7½" 12/bx

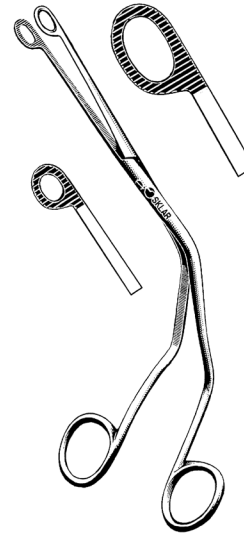

**MAGILL CATHETER FORCEPS**

21-285 7¼" 12/bx  
21-289 9¾" 12/bx

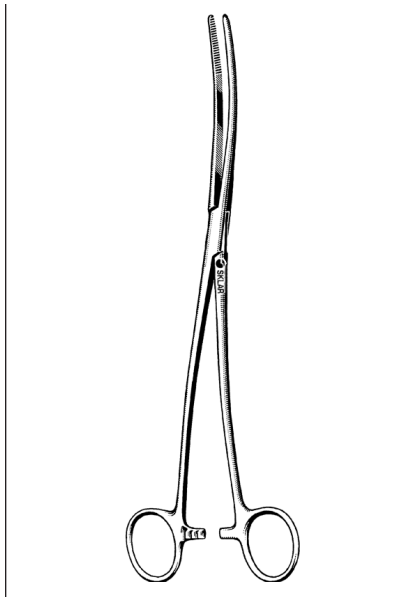

**BOZEMAN SPONGE FORCEPS**

21-374 10¼" S-Curve 12/bx

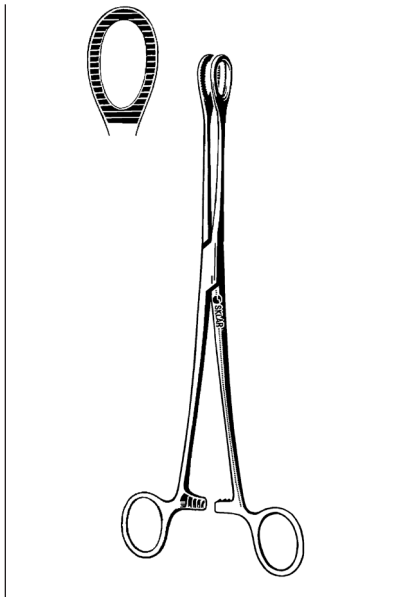

**BALLENGER SPONGE FORCEPS**

**STRAIGHT**

21-571 7" Serrated 12/bx

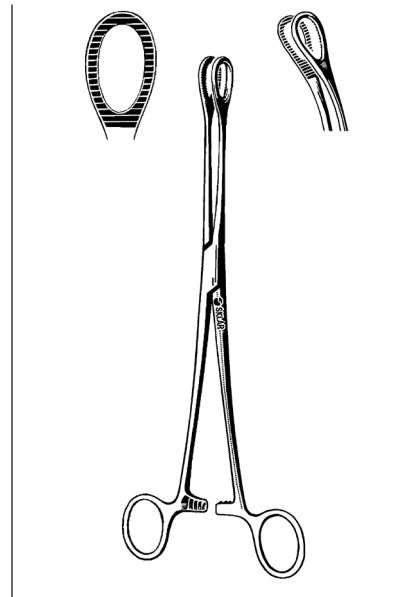

**FOERSTER SPONGE FORCEPS**

**SERRATED**

21-577 9½" Straight 12/bx  
21-586 9½" Curved 12/bx

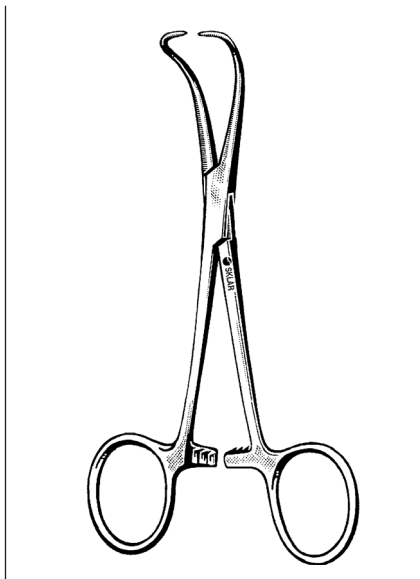

**BACKHAUS TOWEL FORCEPS**

21-606 3½" 12/bx  
21-608 5¼" 12/bx

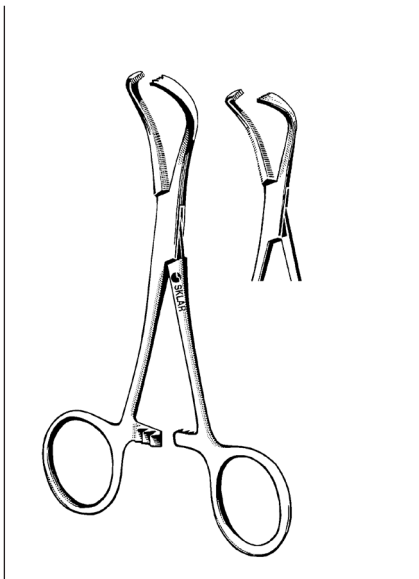

**LORNA-EDNA TOWEL CLAMPS**

21-604 3½" 12/bx  
21-635 5¼" 12/bx

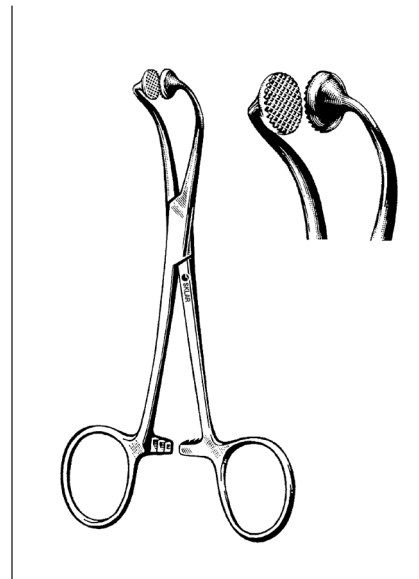

**HOFF TOWEL CLAMPS**

21-611 5¼" 12/bx  
21-655 6¼" 12/bx



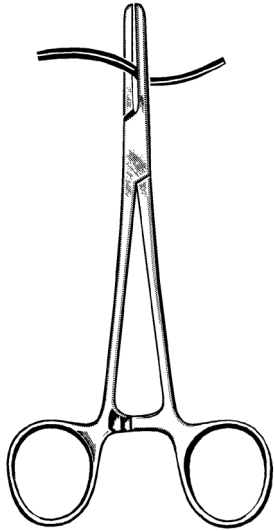

**TUBE OCCLUDING FORCEPS**

21-598	7"	Smooth	12/bx
21-599	7"	Serrated	12/bx

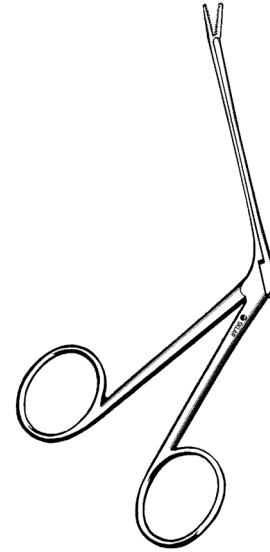

**HARTMANN ALLIGATOR FORCEPS**

21-209	3½"	Serrated	12/bx
21-224	5½"	Serrated	12/bx
21-232	6½"	Serrated	12/bx

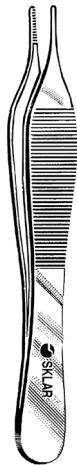

**ADSON FORCEPS**

21-771	4¾"	Serrated	12/bx
21-772	4¾"	Serrated, Delicate	12/bx
21-775	4¾"	1x2 Teeth	12/bx
21-776	4¾"	1x2 Teeth, Delicate	12/bx



**ADSON BROWN FORCEPS**

<b>7X7 TEETH, SIDE GRASPING</b>			
21-778	4¾"		12/bx

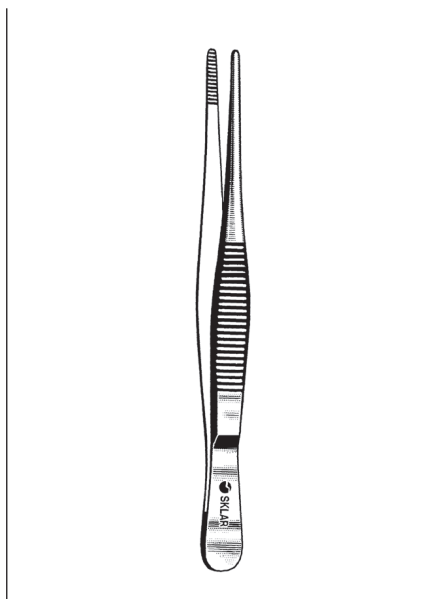

**DRESSING FORCEPS**

21-705	4½"	12/bx
21-710	5"	12/bx
21-727	5½"	12/bx
21-731	6"	12/bx
21-736	8"	12/bx
21-742	10"	12/bx

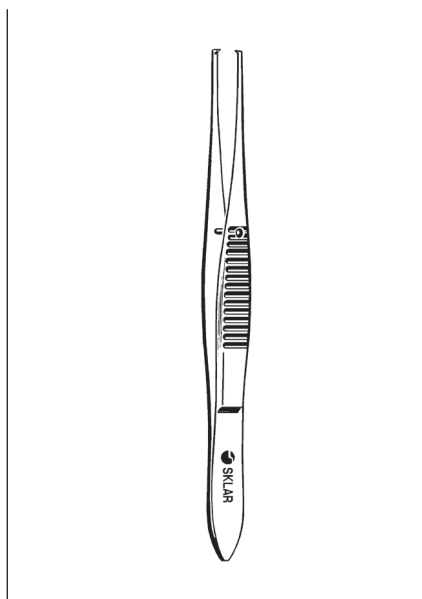

**TISSUE FORCEPS**

<b>1X2 TEETH</b>		
21-142	4"	12/bx
21-753	4½"	12/bx
21-757	5"	12/bx
21-762	5½"	12/bx
21-766	6"	12/bx
21-770	8"	12/bx

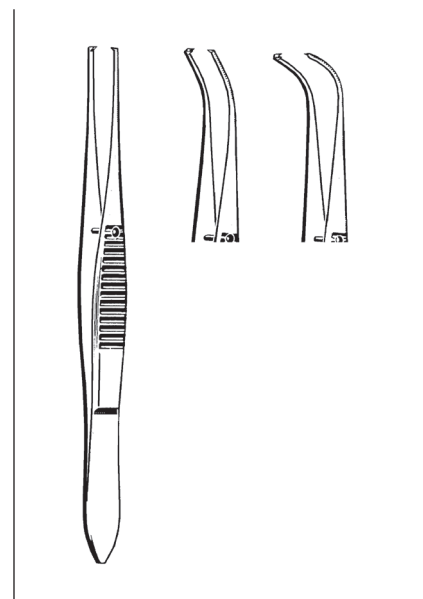

**IRIS FORCEPS**

21-128	2½"	Half Curve, Serrated	12/bx
21-123	4¼"	Straight, Serrated	12/bx
21-124	4¼"	Straight, 1x2 Teeth	12/bx
21-129	4¼"	Half Curve, Serrated	12/bx
21-135	4¼"	Full Curve, Serrated	12/bx
21-146	4¼"	Half Curve, 1x2 Teeth	12/bx
21-151	4¼"	Full Curve, 1x2 Teeth	12/bx
21-129TP	4¼"	Half Curve, Serrated With Tip Protector	12/bx

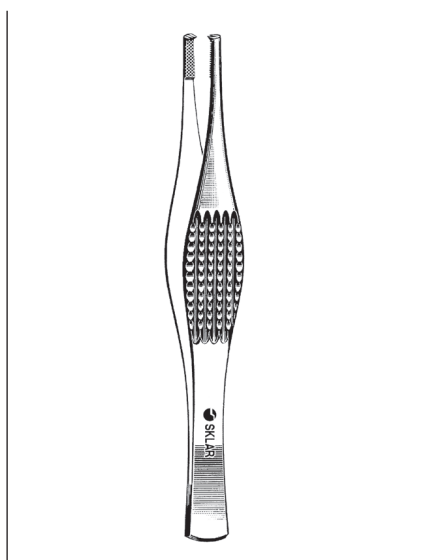

**FERRIS-SMITH TISSUE FORCEPS**

**SERRATED, PLATFORM TIPS**

21-449	7"	1x2 Teeth	12/bx
--------	----	-----------	-------

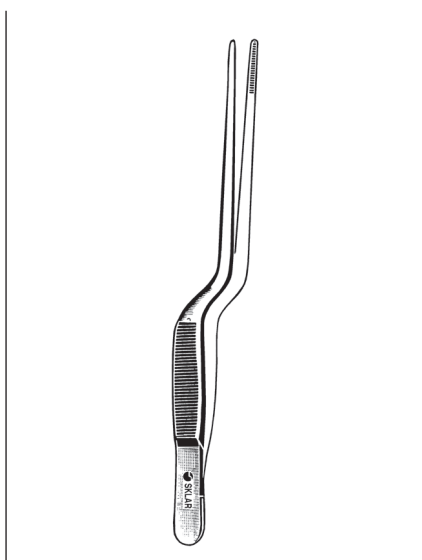

**ADSON BAYONET FORCEPS**

21-188	7½"	Delicate	12/bx
--------	-----	----------	-------

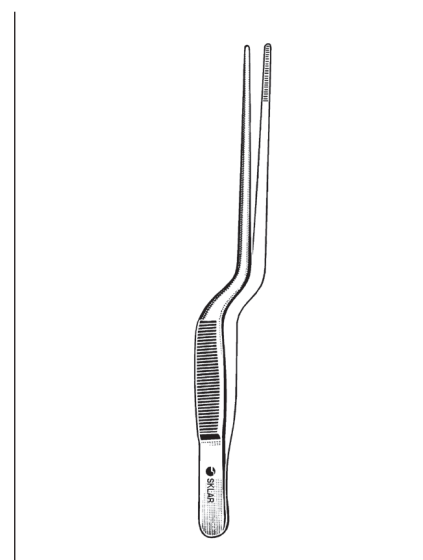

**LUCAE BAYONET EAR FORCEPS**

21-180	5½"	12/bx
--------	-----	-------

**ECONO**  
**FLOOR GRADE FORCEPS**

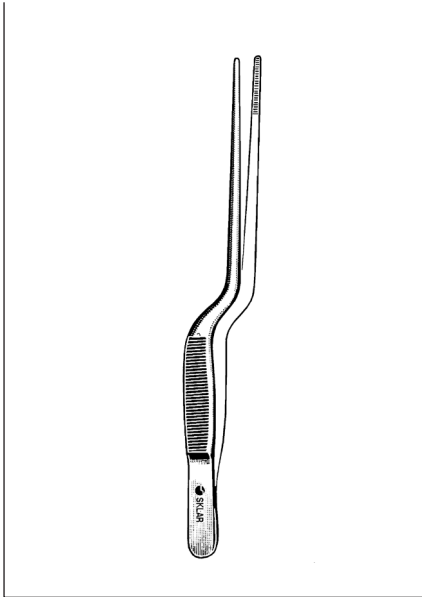

**JANSEN BAYONET FORCEPS**  
SERRATED  
21-605 6½" 12/bx

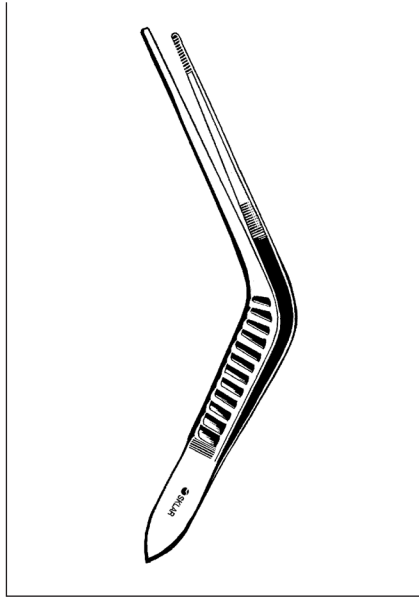

**WILDE EAR FORCEPS**  
ANGULAR, SERRATED  
21-227 5" 12/bx

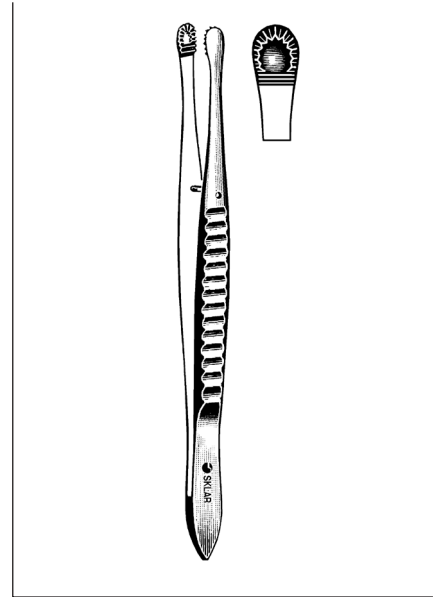

**RUSSIAN TISSUE FORCEPS**  
21-607 8" 12/bx

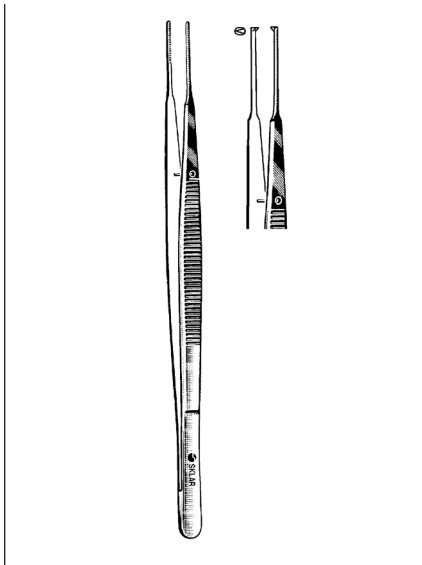

**GERALD FORCEPS**  
STRAIGHT  
21-610 7" Serrated 12/bx  
21-612 7" 1x2 Teeth 12/bx

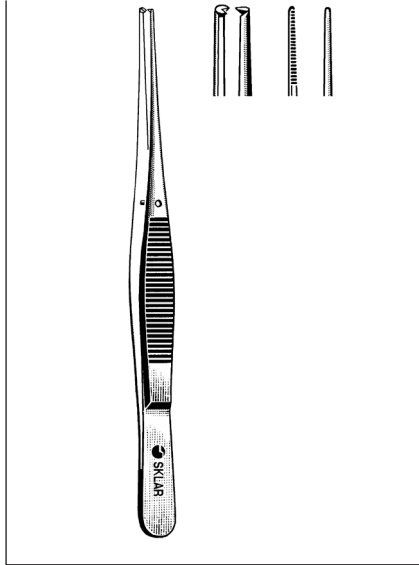

**SEMKIN FORCEPS**  
SERRATED  
21-478 5" Delicate 12/bx

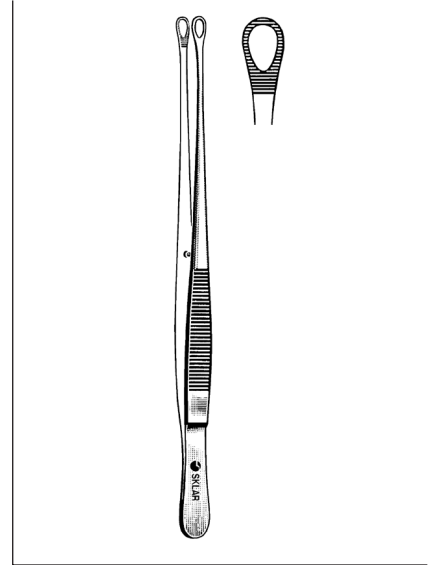

**TUTTLE FORCEPS**  
21-617 7" 12/bx



FLOOR GRADE FORCEPS

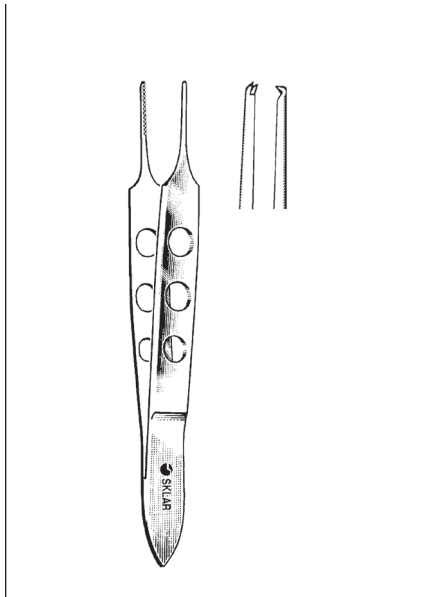

**BISHOP-HARMON IRIS FORCEPS**

21-764 3½" 1x2 Teeth 12/bx

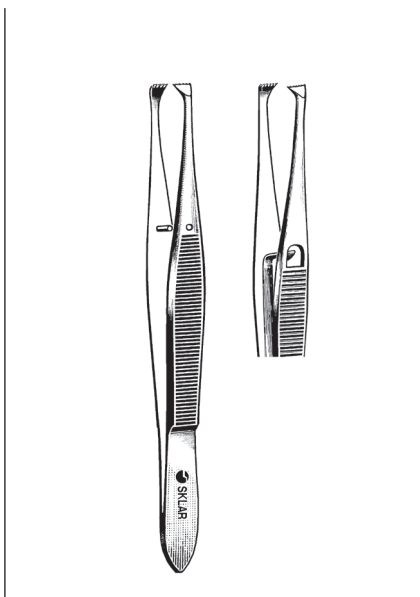

**GRAEFE FIXATION FORCEPS**

21-785 4½" Without Catch 12/bx  
21-788 4½" With Catch 12/bx



**PLAIN SPLINTER FORCEPS  
3" WITH MAGNIFIER, NON-AUTOCLAVABLE**

21-708 3" 12/bx  
21-777 3½" 12/bx  
21-790 4" 12/bx  
21-781 4½" 12/bx



**CARMALT SPLINTER FORCEPS**

21-791 4½" Straight 12/bx  
21-793 4½" Angled 12/bx



**SWISS JEWELER STYLE  
FORCEPS**

**NON-MAGNETIC, STAINLESS STEEL**

21-817 4½" #5 Straight 12/bx  
21-819 4½" #7 Curved 12/bx

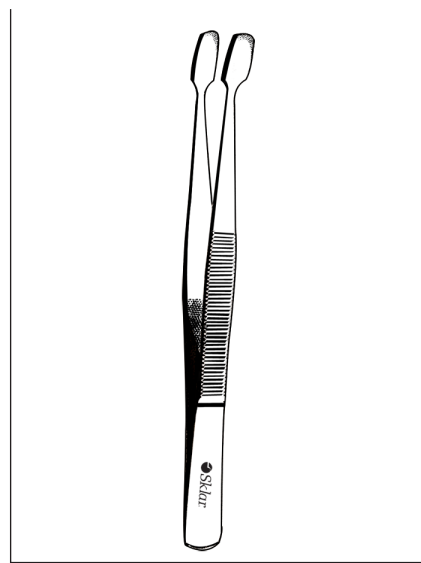

**COVER GLASS FORCEPS**

21-900 Angled 12/bx



**ECONO**  
**FLOOR GRADE NEEDLE HOLDERS**

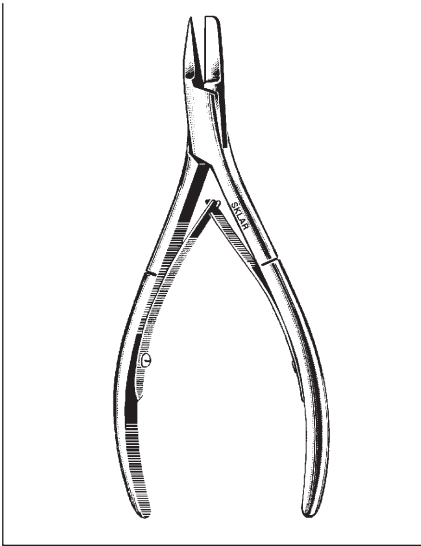

**NAIL SPLITTING FORCEPS**  
ENGLISH ANVIL PATTERN

21-479 5" 12/bx

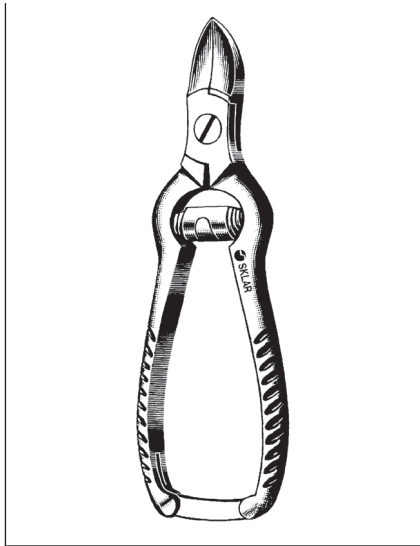

**NAIL NIPPER**  
CONCAVE, 12/BX

21-482	5½"	Double Spring	12/bx
21-483	5½"		12/bx
21-484	5½"	Angled	12/bx
21-486	4½"	Barrel Spring	12/bx
21-472	5½"	Barrel Spring	12/bx
21-493	5½"	Double Spring with lock	12/bx
21-497	4½"	Folding Lock	12/bx

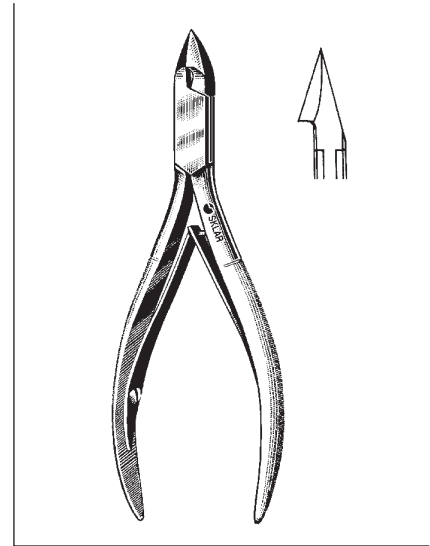

**TISSUE NIPPER**  
CONVEX JAW

21-489 4½" 12/bx



**BAUMGARTNER**  
**NEEDLE HOLDER**

21-832 5½" Serrated 12/bx

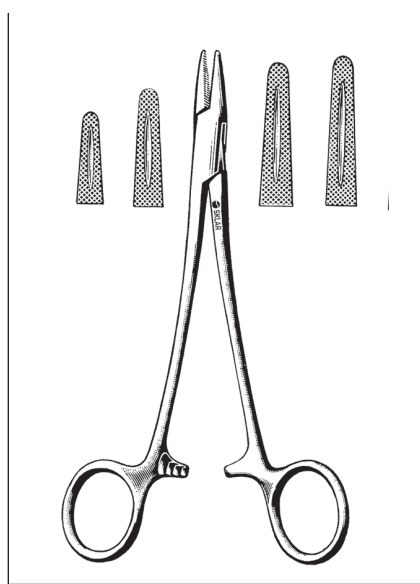

**MAYO-HEGAR NEEDLE HOLDERS**  
SERRATED

21-842	5"	12/bx
21-847	6"	12/bx
21-853	7"	12/bx
21-869	8"	12/bx

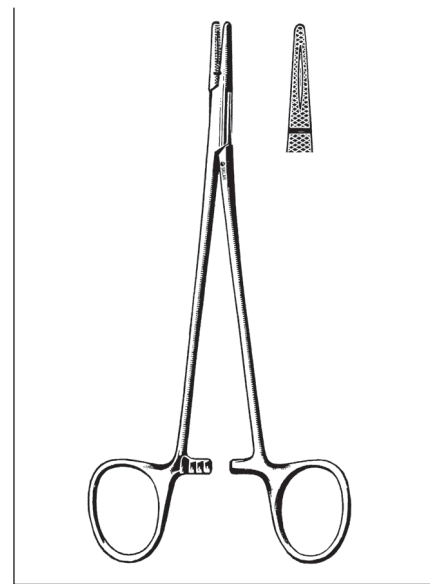

**CRILE-WOOD NEEDLE HOLDER**  
SERRATED

21-838 6" 12/bx



**ECONO**

**FLOOR GRADE NEEDLE HOLDERS**

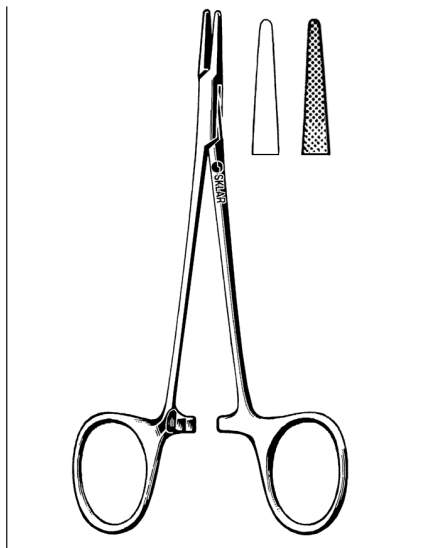

**WEBSTER NEEDLE HOLDERS**

21-809 5¼" Smooth 12/bx  
21-813 5¼" Serrated 12/bx

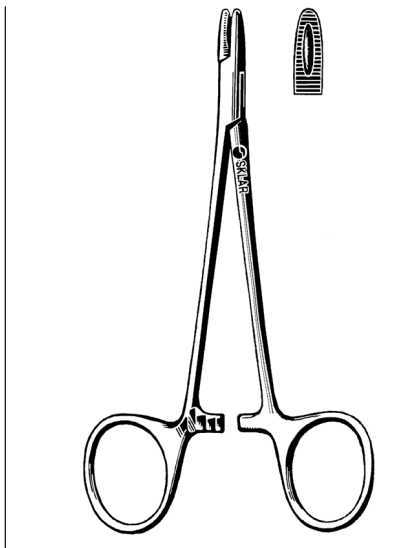

**DERF NEEDLE HOLDER**

21-826 4¾" Serrated 12/bx

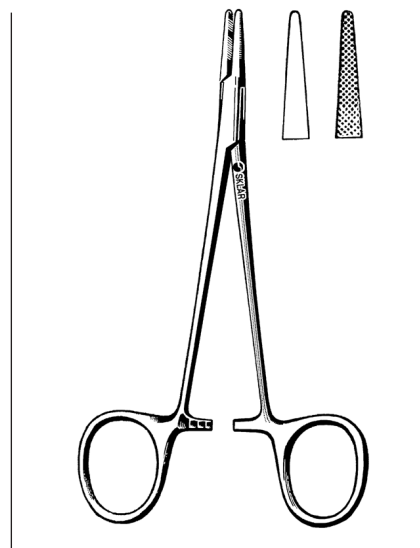

**HALSEY NEEDLE HOLDERS**

21-810 5" Smooth 12/bx  
21-812 5¼" Serrated 12/bx



**OLSEN-HEGAR NEEDLE HOLDERS**

**SCISSOR COMBINATION**

21-872 5½" 12/bx  
21-877 6" 12/bx



**COLLIER NEEDLE HOLDER**

21-885 5¼" Serrated, Fenestrated 12/bx

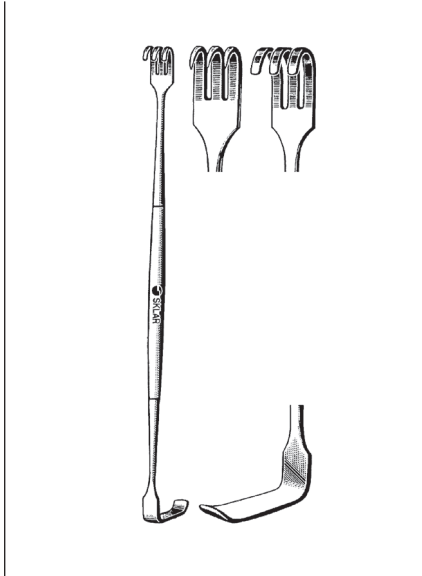

**SENN RETRACTORS**

**DOUBLE END**

21-366	6¼"	Sharp	12/bx
21-365	6¼"	Blunt	12/bx

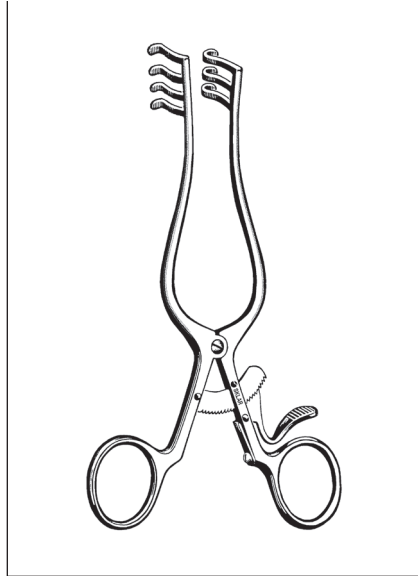

**WEITLANER RETRACTOR**

**BLUNT**

21-371	4½"	2x3 Prongs	12/bx
--------	-----	------------	-------



**GELPI RETRACTOR**

21-805	7"	12/bx
--------	----	-------

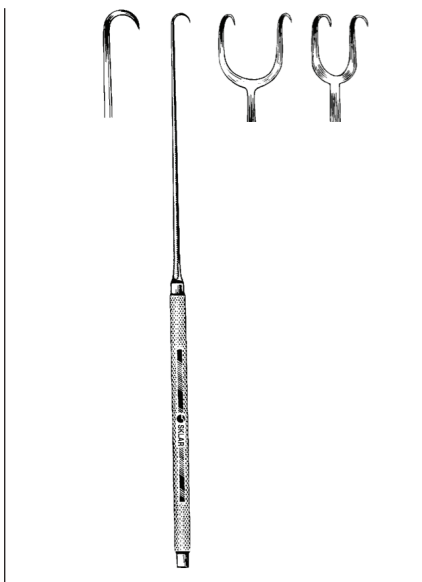

**JOSEPH SKIN HOOKS**

**SHARP**

21-390	6¼"	-	1 Prong	12/bx
21-392	6¼"	2 mm	2 Prong	12/bx
21-394	6¼"	5 mm	2 Prong	12/bx

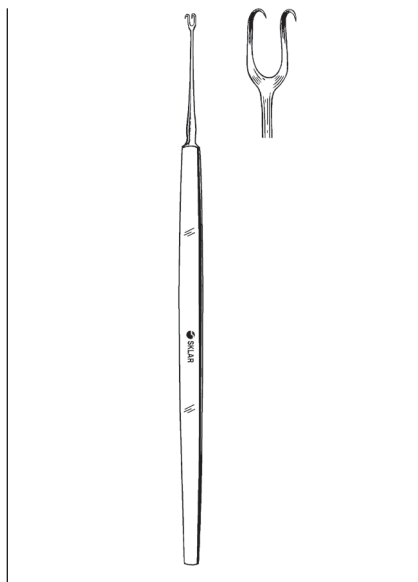

**GUTHRIE DOUBLE HOOK**

**SHARP**

21-821	5"	5mm	2 Large Prong	12/bx
--------	----	-----	---------------	-------

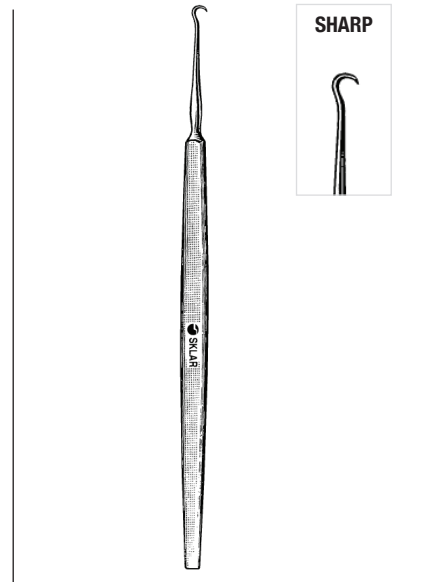

**FRAZIER TISSUE HOOK**

21-801	5"	Sharp	12/bx
--------	----	-------	-------

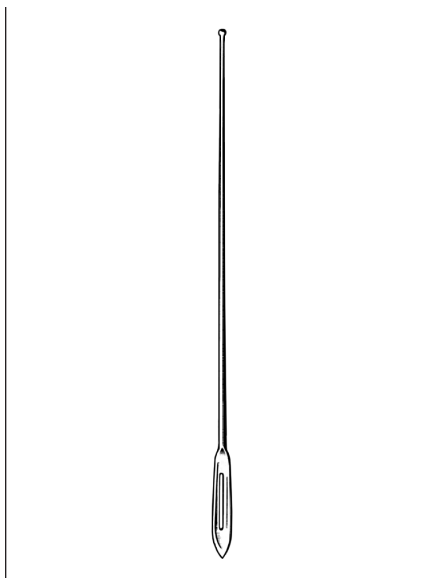

**PROBES  
WITH EYE**

21-499	5"	12/bx
21-502	6"	12/bx

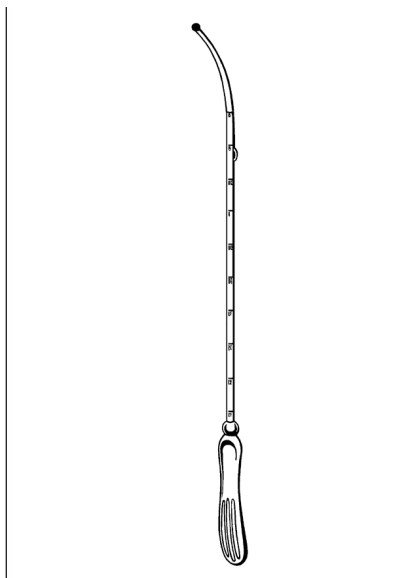

**SIMPSON UTERINE SOUND  
CM GRADUATION SILVER**

21-382	12/bx
--------	-------

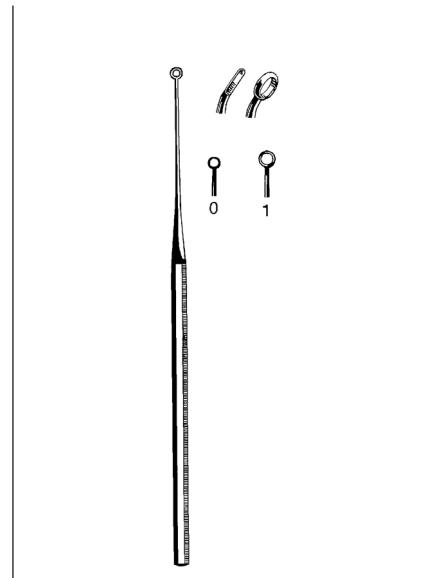

**BUCK EAR CURETTES**

**BLUNT, STRAIGHT**

21-171	#0	12/bx
21-172	#1	12/bx

**BLUNT, ANGLED**

21-165	#1	12/bx
--------	----	-------

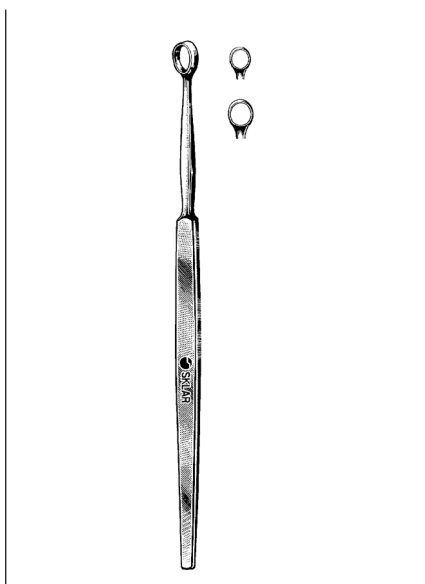

**FOX DERMAL CURETTES**

**ROUND**

21-184	5½"	3 mm	12/bx
21-186	5½"	4 mm	12/bx

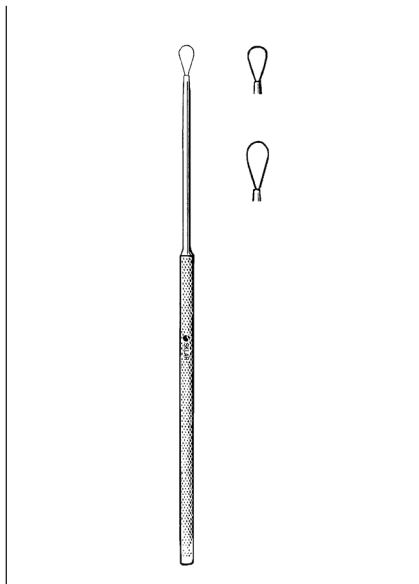

**BILLEAU EAR LOOPS**

21-176	Small	12/bx
21-177	Medium	12/bx

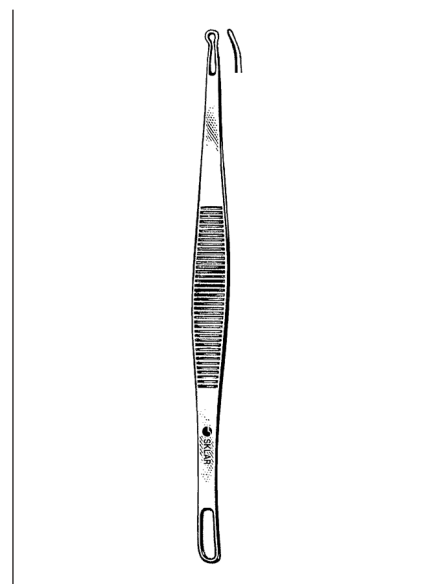

**SHAMBERG COMEDONE  
EXTRACTORS**

21-740	Regular	12/bx
21-741	Extra-Fine	12/bx
21-743	Square	12/bx



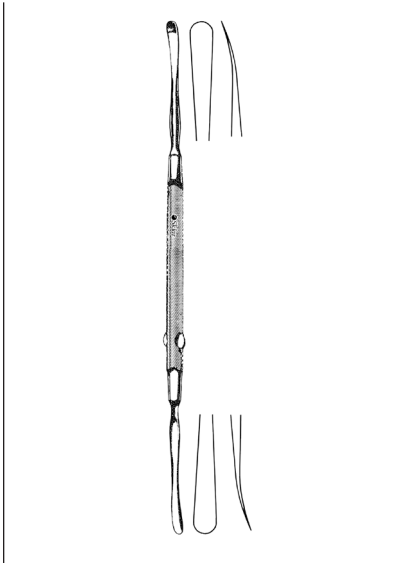

**FREER ELEVATOR**  
**DOUBLE END, SHARP/BLUNT**  
21-748 7¼" 12/bx

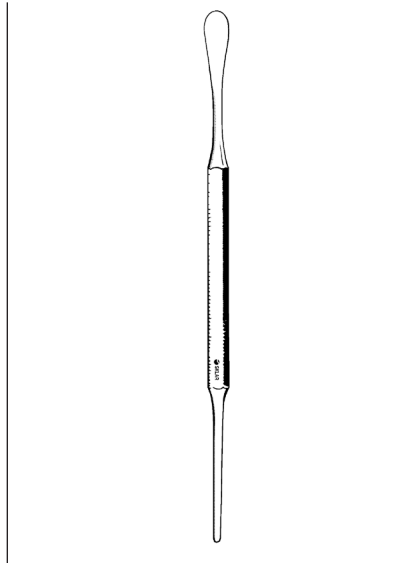

**SPATULA AND PACKER**  
**DOUBLE END**  
21-797 12/bx

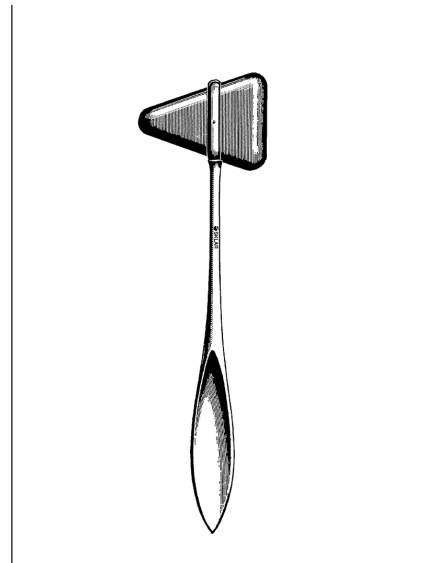

**TAYLOR HAMMERS**  
21-008 7" Small 12/bx  
21-010 7½" 12/bx



**GRAVES VAGINAL SPECULUMS**  
21-303 3" x ¾" Small 12/bx  
21-313 4" x 1¼" Medium 12/bx  
21-324 4½" x 1⅜" Large 12/bx  
21-322 4¾" x 1½" Extra 12/bx  
Large



**PEDERSON VAGINAL SPECULUMS**  
21-334 2¾" x ½" Extra Small 12/bx  
21-337 3" x ½" Small 12/bx  
21-348 4" x ⅜" Medium 12/bx  
21-362 4¾" x 1" Large 12/bx  
21-368 4¾" x 1⅝" Extra Large 12/bx

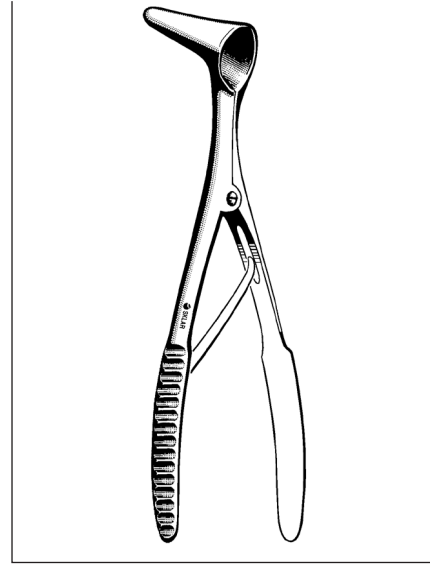

**VIENNA NASAL SPECULUMS**  
21-258 Adult Size 12/bx  
21-267 Pediatric Size 12/bx